

# VERSACARD

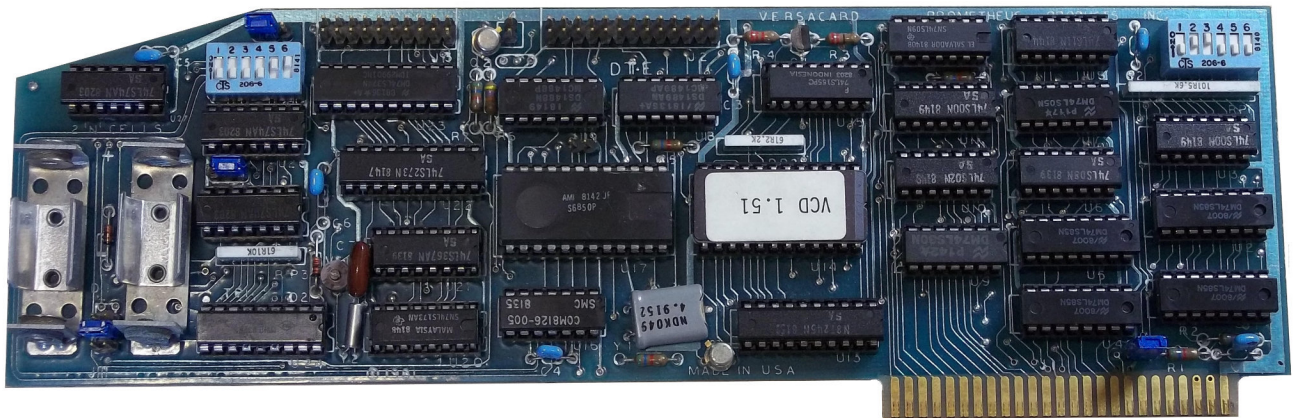

**PROMETHEUS**  
PRODUCTS INCORPORATED

**NEW...FOR APPLE II<sup>(1)</sup>**

FROM PROMETHEUS

# VERSACard

1. Serial Input/Output Interface
2. Parallel Output Interface
3. Precision Clock/Calendar
4. BSR Control



**ALL ON ONE CARD**  
with true simultaneous operation  
...at a down-to-earth price!

**CHECK THESE FEATURES:** True simultaneous operation!

VERSACard's unique hardware selection circuitry make your Apple "think" that separate cards are installed. This allows VERSACard interface ports to be compatible with existing software such as APPLE PASCAL, Microsoft Softcard<sup>(2)</sup>, and most other Apple software.

The **Serial Input/Output port** is RS-232C standard with crystal controlled baud rates from 19.2K to 110 baud. You can connect with a CRT terminal, line printer, or virtually any RS-232 modem. VERSACard's "Terminal" mode, along with modem, connects you with the *Source* or a variety of other computers. "Terminal" mode also allows you to output to both printer and display simultaneously.

The versatile **Parallel Output Interface** is configured for the Centronics standard and is easily configured for other standards. Simply hookup your **Epson, Okidata, IDS**, or other printer and begin printing.

**Precision Clock/Calendar.** With all standard real-time clock/calendar functions and one second resolution.

Battery back-up supplied. And, best of all, it's **software compatible with Thunderclock**. This makes numerous other software packages immediately usable. Interrupts are supported.

**BSR Control.** Add an ultrasonic transducer, and VERSACard provides you with remote control through your BSR X-10 Home Control System.

**Onboard firmware** provides optional auto line feed, video, paging, terminal mode, lower to upper case, 8th bit set or clear ... and more. These versatile device drivers permit connection to virtually any standard peripheral. The Prometheus engineering staff is available to help. With any peripheral and special device interface problems. Call us, we'd like to hear from you.

**VCD-1 VERSACard @ \$249.00 each.**

| Compare Key Features                          | VersaCard | CPS Multifunction Card          |
|---|-----------|---------------------------------|
| Parallel, Serial & Real Time Clock Interfaces | Yes       | Yes                             |
| BSR Control Interface                         | Yes       | No                              |
| Compatible with Apple Pascal                  | Yes       | No Special Pascal disk required |
| Compatible with CP/M                          | Yes       | No Special CP/M disk required   |
| Interrupts?                                   | Yes       | No                              |
| Apple modification?                           | No        | Yes                             |

NEW... Applications/Diagnostics disk available 1st quarter 1982

 **NOTE!**



Dealer inquiries invited.

**VERSACard—the only Apple peripheral card you're likely ever to need!**

All Prometheus boards are completely tested and burned-in prior to shipment. A one-year warranty covers parts and labor.

Registered Trade Marks, (1) Apple Computers, Inc. (2) Microsoft Consumer Products

# PROMETHEUS

**PROMETHEUS PRODUCTS INCORPORATED**

42577 Fremont Blvd. • Fremont, CA 94538 • (415) 490-2370

# TABLE OF CONTENTS

|   |    |
|---|----|
| 1. INTRODUCTION.....                                      | 1  |
| 2. INSTALLATION INSTRUCTIONS.....                         | 2  |
| 2.1. General Information.....                             | 2  |
| 2.2. Suggestions on Slot Assignments.....                 | 2  |
| 2.3. Slot Assignment Examples.....                        | 3  |
| 2.4. Cable Configuration and Installation.....            | 5  |
| 2.4.1. Serial cable Configuration .....                   | 6  |
| 2.4.2. Parallel Cable Configuration .....                 | 6  |
| 2.4.3. IDS Parallel Cable.....                            | 7  |
| 2.5. Parallel Interface Configuration.....                | 8  |
| 2.6. Real Time Clock Configuration.....                   | 8  |
| 2.6.1. Clock Interface in CP/M and Apple Pascal.....      | 8  |
| 2.7. Serial Interface Configuration.....                  | 8  |
| 2.8. BSR/Ultrasonic Transducer Configuration.....         | 8  |
| 3. Installing the VERSAcord into the Apple.....           | 9  |
| 3.1. First time powerup after installation.....           | 9  |
| 3.2. Common Installation 'Gotchas'.....                   | 10 |
| 4. Testing out the Interfaces.....                        | 11 |
| 4.1. Serial and Parallel Interface.....                   | 11 |
| 4.2. Real Time Clock.....                                 | 12 |
| 4.3. Clock/Calendar Interfaces in CP/M and Apple Pascal.. | 12 |
| 4.4. Interrupts.....                                      | 12 |
| 4.5. BSR Interface.....                                   | 13 |
| 5. SERIAL INTERFACE HARDWARE.....                         | 13 |
| 5.1. General Information.....                             | 13 |
| 5.1.1. Current Loop and Teletypes.....                    | 14 |
| 5.2. RS-232C Pin Descriptions.....                        | 14 |
| 5.3. Serial Port Data Format.....                         | 16 |
| 5.4. Slot Selection.....                                  | 16 |
| 6. PARALLEL PRINTER INTERFACE HARDWARE.....               | 17 |
| 6.1. General Information.....                             | 17 |
| 6.2. Parallel Printer Interface Disable Switch.....       | 18 |
| 7. CLOCK/BSR HARDWARE.....                                | 19 |
| 7.1. General Information.....                             | 19 |
| 7.2. Slot Selection.....                                  | 19 |
| 7.3. Clock Write-Protect Switch.....                      | 19 |
| 7.4. Batteries.....                                       | 19 |
| 7.5. Trimmer Adjustment - Time Accuracy.....              | 19 |
| 7.6. BSR Connector - J4.....                              | 20 |
| 7.7. Interrupts.....                                      | 20 |
| 7.7.1. Problems with Interrupts.....                      | 21 |
| 7.7.2. Interaction with VERSAcord Firmware.....           | 21 |
| 7.7.3. Enabling and Disabling Interrupts.....             | 21 |

|  |    |
|--|----|
| 8. Software.....   | 23 |
| 8.1. General Comments.....                               | 23 |
| 8.2. Serial and Parallel Firmware Commands.....          | 24 |
| 8.3. Software considerations when using Apple Pascal and | 26 |
| 8.4. Other Software and Hardware Considerations.....     | 27 |
| 8.5. Terminal Mode.....                                  | 27 |
| 8.6. Clock Firmware.....                                 | 29 |
| 8.6.1. Input/Output Mode Characters.....                 | 29 |
| 8.6.2. Reading and setting the time.....                 | 30 |
| 8.6.3. Reading and setting the year.....                 | 32 |
| 8.6.4. Clock Assembly Language Interface.....            | 33 |
| 9. Use and Features of BSR/X-10 Interface.....           | 34 |
| 9.1. General Information.....                            | 34 |
| 9.2. Sending Remote Commands.....                        | 34 |
| 9.3. Example of Use with BSR Remote Modules.....         | 35 |
| 9.4. Bright and Dim Controls.....                        | 35 |
| 9.5. Duration Control.....                               | 35 |

## Appendices

|   |    |
|---|----|
| A. Assembly Language Interrupt Program.....           | 37 |
| B. HARDWARE REGISTERS AND MEMORY MAP INFORMATION..... | 40 |
| C. IMPORTANT FIRMWARE LOCATIONS.....                  | 41 |
| D. 6850 UART HARDWARE REGISTER SUMMARY.....           | 42 |
| E. CLOCK DATA REGISTERS.....                          | 45 |
| F. TROUBLESHOOTING.....                               | 47 |
| G. SPECIFIC SERIAL DEVICES CABLING REQUIREMENTS.....  | 48 |
| H. PROGRAM TO READ THE CLOCK/CALENDAR in CP/M.....    | 51 |
| I. SWITCH SETTINGS, PARTS LIST AND DIAGRAM.....       | 52 |
| INDEX .....   | 56 |

NOTE: FOR SWITCH BANK DIAGRAMS SEE PAGE 4

## L I S T   O F   F I G U R E S

---

|  |    |
|--|----|
| 2-1: Parallel and Serial Cable Installation.....   | 5  |
| 2-2: IDS Printers Parallel cable pinout.....       | 7  |
| 4-1: Printer Checkout Program.....                 | 11 |
| 5-1: J2 (serial port) pinout numbering.....        | 13 |
| 6-1: J3 - Parallel Interface Pin Descriptions..... | 17 |
| 6-2: J3 Pinout numbering.....                      | 17 |
| 7-1: JH1 - Interrupt Rate Selection.....           | 20 |
| 8-1: VERSAcad Memory Map.....                      | 24 |
| 8-2: Clock Assembly Language Read Routine.....     | 33 |
| 9-1: BSR Use Sample Program.....                   | 35 |

## L I S T   O F   T A B L E S

---

|  |    |
|--|----|
| 4-1: Real Time Clock Programs.....                       | 12 |
| 5-1: VERSAcad RS-232 pinout definitions .....            | 14 |
| 7-1: Sample interrupt service routine.....               | 21 |
| 8-1: Firmware Options for Serial and Parallel Ports..... | 23 |
| 8-2: Firmware Command Definitions.....                   | 24 |
| 8-3: Terminal Mode Command Characters.....               | 28 |
| 8-4: Real Time Clock Mode Characters.....                | 30 |
| 8-5: Programs to read the Real Time Clock.....           | 31 |
| 8-6: Program to set the Real Time Clock.....             | 31 |
| 8-7: Programs to read the year.....                      | 32 |
| 8-8: Program to set the year.....                        | 32 |
| 9-1: BSR Button Codes.....                               | 34 |
| 9-2: BSR Duration Codes.....                             | 36 |

**FRONT COVER DESIGN BY DR. KENNETH BUCHHOLZ**

## 1. INTRODUCTION

VERSACard provides the APPLE user with the four most popular APPLE peripheral functions on one card. VERSACard provides four logically separate functions: Serial device interface, Parallel device interface, Real Time Clock/Calendar, and BSR/X-10 control. Unique hardware incorporated in the slot selection logic of VERSACard allows the user to configure the logical functions into slots other than the physical slot into which the card is inserted. This allows VERSACard to maintain complete compatibility with APPLE PASCAL, 2-80 CP/M, and all standard APPLE software without the need for special disks or modifications to the user's APPLE.

The asynchronous serial port is RS-232C DTE (Data Terminal Equipment) standard and features half or full duplex operation at standard baud rates up to 19.2K. A crystal controlled baud rate generator circuit is used to provide accurate interface rates. The firmware and hardware allow easy interfacing to most popular serial devices (printers).

The parallel printer interface is shipped configured as a standard Centronics interface and can be easily reconfigured for other standards. An optional graphics ROM (Graphitti) is available to dump the Apple HIRES screens via a few simple keyboard commands.

The Real Time Clock/Calendar is designed to emulate the THUNDERWARE Clock and provides resolution to one second. Firmware drivers are compatible with APPLE clock access programs. On-card batteries provide power to the clock circuit for retaining clock operation for greater than two years with the APPLE turned OFF.

With the addition of an optional ultrasonic transducer VERSACard can provide BSR SYSTEM X-10 remote control of A/C accessories.

## 2. INSTALLATION INSTRUCTIONS

### 2.1. General Information

```
*****
*
*
*   VERSAcad was designed to be as easy to interface as is
*   reasonably possible with an APPLE II computer. The
*   firmware and hardware was also designed to be compatible
*   with most existing software packages that can use standard
*   APPLE peripherals.
*
*   To maintain compatibility and proper operation of the
*   VERSAcad it must be installed properly. Since the VERSAcad
*   contains four functions on one card it is slightly more
*   complicated to install than most single function peripheral
*   cards. Please read the configuration section carefully as it
*   contains much valuable information.
*
*
*****
```

### 2.2. Suggestions on Slot Assignments

VERSAcad contains four different functions, which must be assigned to the appropriate slot in which they are going to be used. This needs to be done before you physically install the VERSAcad in your Apple II computer. The Real Time Clock and the Parallel Printer functions are called "phantom" interfaces. A phantom interface can be set up to operate just as if it were physically in the slot for which it is phantomed. The user must configure VERSAcad in order to select which slots the VERSAcad phantom interfaces will be set. The following are guidelines which will help you in selecting which function should be set for which slot. The actual switch settings to determine slot selection are shown in Appendix I but are discussed below.

1 - Find out in which slot your software expects the interface to be located. Most recently written software packages will allow the interface to be in any slot. Configure the VERSAcad interface in question to match where your software expects it to be but try to follow the guidelines for slot configuration as shown in #2 below.

Should you ever change slot configuration on the VERSAcad make sure that you reconfigure your software package should you need to do so.

2 - CP/M and Apple Pascal operating systems expect the printer interface (serial or parallel) to be in slot 1, the REMIN/REMOUT device to be in Slot 2 (usually a modem interface), and the console device in Slot 3 (most commonly an 80 column card).

3 - The VERSAcad serial interface cannot be disabled. The serial interface shows up in the slot that you PHYSICALLY put the VERSAcad into.

4 - If you intend to use Apple Pascal or CP/M, DO NOT put the VERSAcad into slot 3, unless you are using an external terminal or any other device intended to be used as the console device.

When the VERSAcad is put into slot 3 it will be recognized as the console port by CP/M and Apple Pascal. These operating systems will assume that an external terminal has been hooked up and try to obtain input/output from the serial interface. Should no external terminal be connected then your system will appear to "hang". 80 column cards have the same signature bytes as serial cards and CP/M and Apple Pascal assume both are for the same purpose.

5 - The clock and the BSR interface functions are most often installed for slot 4 or 7. The BSR interface function is located in the same slot as you choose to locate the clock function. The clock/BSR phantom interface can be assigned to the same slot as a 2-80 type of card or typically any card that does not have ROM located on the card. i.e. 6809 Mill processor card

6 - VERSAcad does NOT allow another interface card to be physically inserted in the same slot that a function on VERSAcad is phantom. The only exception is noted above.

Again, we suggest that you try to maintain compatibility with the CP/M and Apple Pascal standard configurations as described in item 2 above as many software vendors are now following these guidelines in their software packages. Remember that the Serial Interface cannot be disabled.

### 2.3. Slot Assignment Examples

VERSAcad comes from the factory with the slot selection switches already configured;

SLOT 1 - Parallel Printer Interface  
SLOT 4 - Real Time Clock/BSR Interface

The Serial Interface will show up in whatever slot you physically put the VERSAcad into.

Should VERSAcad be inserted into slot 2 of your Apple (as described in the first below) it would meet all the criteria to be compatible with the Apple Pascal and CP/M protocol as described previously.

**\*\* SEE APPENDIX I FOR COMPLETE SWITCH SETTING INFORMATION \*\***



SW 1.2.3 SW 4.5.6  
 PRINTER CLOCK  
 SLOT SLOT  
 SELECTION SELECTION

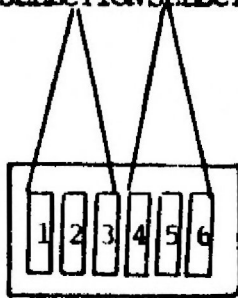

SWITCH BANK I

SW 1 SW 6  
 PRINTER CLOCK  
 BUSY WRITE  
 PROTECT

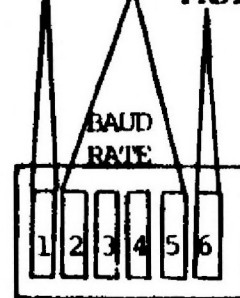

SWITCH BANK II

**Example #1 (Default Settings)**

Parallel = Slot 1      Serial = Slot 2      Clock/BSR = Slot 4  
 9600 Baud

In this example you would physically put the VERSAcad in Slot 2 and no switch setting on S1 would change. Set the baud rate (Appendix B) according to need. The baud rate has been set (switches 2-5 of S2) at 9600 baud.

Switch S1

1=OFF      4=ON  
 2=ON      5=ON  
 3=ON      6=OFF

Switch S2

1=ON      4=OFF  
 2=OFF      5=ON  
 3=OFF      6=OFF

**Example #2**

Parallel = Disabled      Serial = Slot 1      Clock/BSR = Slot 7  
 1200 Baud

The VERSAcad would be installed in Slot 1 of the Apple so that the Serial Interface will show up in this slot. To disable any phantom peripheral the phantom slot assignment switches (S1) have to be set for the same slot where VERSAcad is physically inserted. Therefore, the Parallel Printer phantom slot assignment switches should be set for slot 1. The Parallel Printer phantom switches are set for slot 1 from the factory as the default so no changes would be necessary in this example. ALSO, when disabling the Parallel Printer Interface, switch bank S2, switch #1 MUST BE IN THE OFF POSITION! See Section 6.2 for further information on disabling the Parallel Printer Interface.

Switch S1

|       |       |
|-------|-------|
| 1=OFF | 4=OFF |
| 2=ON  | 5=OFF |
| 3=ON  | 6=OFF |

Switch S2

|       |       |
|-------|-------|
| 1=OFF | 4=OFF |
| 2=ON  | 5=OFF |
| 3=OFF | 6=OFF |

Example #3

Parallel = Slot 1    Serial = not used    clock/BSR = Slot 4  
 300 Baud

(This example assumes a Z-80 type of card in Slot 4)

As stated earlier, the Serial interface cannot be disabled. Normally, three slots would be taken up in this configuration even though the Serial Port is not being used. By phantoming the Clock over the Z-80 card you have not used another physical slot. The net effect is two physical slots are used. Had the Serial interface been used in this example you would have gained 3 functions and only used 2 physical slots. You would put VERSAcad physically into whatever slot was not being used.

Switch S1

|       |       |
|-------|-------|
| 1=OFF | 4=ON  |
| 2=ON  | 5=ON  |
| 3=ON  | 6=OFF |

Switch S2

|       |       |
|-------|-------|
| 1=ON  | 4=ON  |
| 2=ON  | 5=OFF |
| 3=OFF | 6=OFF |

2.4. Cable Configuration and Installation

The only two cables that need to be installed on VERSAcad are the parallel and serial interface cables. All cables supplied from the factory have a red line on one side of the cable. The cables should come from the top of VERSAcad (VERSAcad is component side up, Apple connector facing down) with the red line to the left. Please see Figure 2-1.

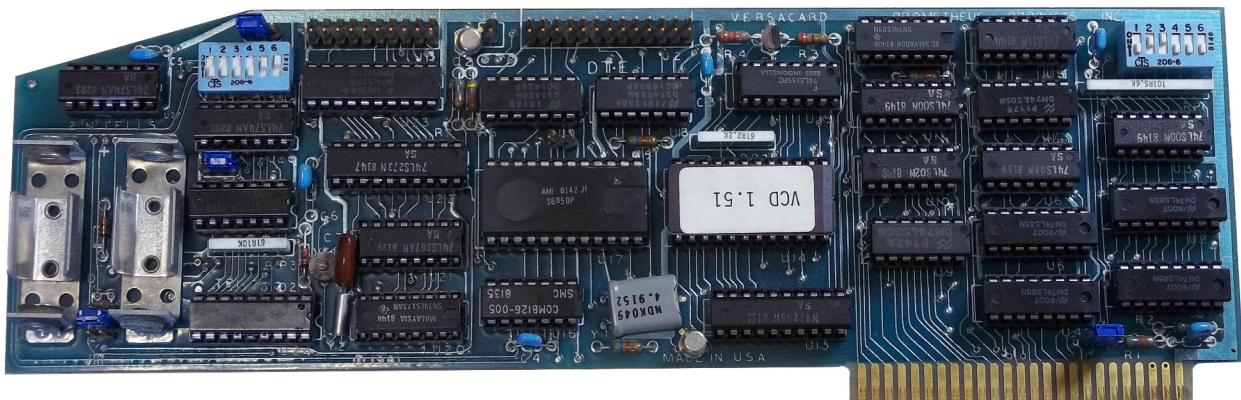

Figure 2-1: Parallel and Serial Cable Installation

### 2.4.1. Serial cable Configuration

The serial interface is the most difficult interface to configure when connecting to peripherals because of the many different serial peripherals and their vastly different cabling requirements. The user should not assume that just because two serial devices are RS-232C compatible that they will hook together with no cable modifications necessary. To coin a phrase, RS-232C compatibility only guarantees that two RS-232C devices will not "smoke" when hooked together incorrectly. (Even this is not always true!)

The serial interface was designed such that it will usually connect to a modem (such as the SMARTMODEM from Hayes) with no cable modifications. When hooking up any device other than a modem, first look in Appendix G to see if the device is listed there. The RS-232C cabling requirements for many popular RS-232C type accessories are listed in Appendix G. Simply make up a cable (or get one from your local dealer or PROMETHEUS) as defined in Appendix G.

If your device is not listed in Appendix G, the hookup to VERSAcad is more complicated. Section 5.1, 5.2 is a complete explanation of how the RS-232C serial interface on VERSAcad works and the description of the various pins on the serial interface.

```
*****
*
*   THE SERIAL INTERFACE IS THE MOST COMPLICATED TO INTERFACE *
* BECAUSE OF THE MANY DIFFERENT CABLE CONFIGURATIONS. PLEASE READ *
* COMPLETELY SECTION 5.1, 5.2 AND REFER TO APPENDIX G WHICH LISTS *
* THE CABLING REQUIREMENTS FOR SPECIFIC DEVICES. *
*
*****
```

### 2.4.2. Parallel Cable Configuration

The standard parallel cable supplied by PROMETHEUS will work with most currently available dot matrix printers. The parallel interface is wired the same way as an Apple Parallel Printer card and cables that work with it will work with the parallel interface on VERSAcad. This is only true for Revision A, B, C, and D of VERSAcad. The Prometheus part # for this cable is CBL-PAR and is 6 feet long and pinned out as shown in figure 6-1.

Should you have a Revision E VERSAcad the parallel cable has be changed so that it will meet FCC requirement and install correctly inside a Apple Iie computer. The Apple Iie computer has special cutouts in the back of the computer to allow you to

install DB-25 connectors. These type of connectors are usually associated with serial applications. The part # for this cable is CBL-IIE and is a short cable to allow installation from VERSAcards to the back of the APPLE Iie computer.

To connect to your printer from the APPLE Iie another cable will be required. This cable will connect to most popular types of dot matrix printers. Examples of compatible printers with the standard parallel cable are OKI DATA, EPSON, NEC 8023, C-ITOH PROWRITER, and ANADEx. The part # for this cable is CBL-PEX. This cable is 6 feet long.

Now, to make things just a little bit more confusing there is one more type of cable available for Revision E VERSAcards. This cable is 6 feet long and will directly connect from the VERSAcards parallel interface to the types of printers described above. This bypasses the need for the two cable set as described above. This cable is for other Apple compatible computers that are available and are not like the Apple Iie computer. It should be noted that it is possible to use this cable on a Apple Iie computer by knocking out the cover of the DB-25 hole that you would install the CBL-IIE type of cable into and simply passing the cable through this hole. Be forewarned that in doing so you will probably violate Subpart J of Part 15 of the FCC regulation governing emissions from computers.

#### 2.4.3. IDS Parallel Cable

Should you be using an IDS printer, you will need to have a special interface cable. The IDS interface uses a DB-25 type of interface (normally used in serial applications) for the parallel interface as well as the serial interface. This special cable is available from your dealer or PROMETHEUS. The pin out is shown below for your reference. we suggest that you use the parallel interface on IDS printers so that you may use the graphics option on VERSAcards in the future.

| Rev E | VERSAcard | Rev A-D | IDS Printers |
|-------|-----------|---------|--------------|
| 2,20  |           | 1,20    | -----> 7     |
| 1     |           | 8       | -----> 3     |
| 13    |           | 15      | -----> 9     |
| 11    |           | 14      | -----> 10    |
| 9     |           | 13      | -----> 11    |
| 7     |           | 12      | -----> 12    |
| 5     |           | 11      | -----> 13    |
| 3     |           | 10      | -----> 14    |
| 15    |           | 16      | -----> 15    |
| 19    |           | 2       | <----- 22    |

Fig. 2-2: IDS Printers Parallel cable pinout

## 2.5. Parallel Interface Configuration

The Parallel interface needs no configuration other than configuring the cable as discussed previously.

## 2.6. Real Time Clock Configuration

No configuration is necessary to use the clock except for setting the interrupt rate. This rate only needs to be set if you are going to be using interrupts. Because of the complexity of interrupts it is fully discussed in section 7.7 and you should read that entire section before using interrupts.

The clock must appear in its own slot for it to be found and used by different software packages (such as DB MASTER). When the Clock is phantomd over a 2-80 type of card, all functions on the Clock and the 2-80 card work normally.

### 2.6.1. Clock Interface in CP/M and Apple Pascal

CP/M and Apple Pascal have NO STANDARD interface to the real time clock/calendar and require special software to read the time. A program to read the time under CP/M is contained in Appendix H. The program to read the time and automatically set the date upon powerup in Apple Pascal is available from Prometheus as part of the optional APPLICATIONS and DIAGNOSTICS DISK.

## 2.7. Serial Interface Configuration

Once the cable is correctly made only the baud rate needs to be set. The baud rate switch settings can be found in Appendix I.

## 2.8. BSR/Ultrasonic Transducer Configuration

The ultrasonic transducer is installed at J4 located between the parallel and serial I/O connectors. This two pin jumper mates with the jumper coming from the transducer. There is no polarity in the connector, so it does not matter which way you install the transducer. The transducer must be pointed at the BSR COMMAND CONSOLE with no obstructions in between.

### 3. Installing the VERSAcad into the Apple

Once you have set the SLOT CONFIGURATION switches, the BAUD RATE (if needed), the PRINTER DISABLE switch, and the interrupt jumpers (if you are using interrupts) it is time to insert the VERSAcad into your Apple.

First, as with all installations of Apple peripheral cards, make sure that the power is off to your Apple. The power light on the front should be off. Next, take anything off of the top of your Apple that you may have sitting on it and remove the cover. The cover is easily removed by pulling upwards on the lid from the back end of the Apple and then lifting backwards once the back end of the lid is free.

Now that you have the lid of your Apple off you should be able to see the 8 I/O connectors that are in the back of your Apple. These are where you put the VERSAcad. If you have carefully read the entire installation section up to this point you should have decided where you PHYSICALLY want to put the VERSAcad.

The VERSAcad can only be put in in one direction so there is no danger in putting it in backwards. The slots are numbered 0-7 starting from your left when you are facing the Apple keyboard. The I/O connectors are also marked behind the connector so there should be no mistake as to where to put the VERSAcad. Gently seat the VERSAcad in the Apple I/O connector that you picked making sure that it is firmly seated in the I/O connector.

If you have cables installed fold them so that they go out one of the vertical cutouts that appear in the back of your Apple II. Should you have an Apple IIe computer you should use the CBL-IIIE type of cable so that you can install it into one of the connectors in the back of the Apple IIe. If there is any confusion about which cable is which you may want to mark them before the Apple is closed up.

#### 3.1. First time powerup after installation

Once the VERSAcad is installed and BEFORE you close the cover back up lets recheck that you have the RIGHT PHYSICAL slot and that the cables are nicely folded. If you want you might check the switch setting also. NOW you will want to turn ON the power switch (Apple lid still OPEN) and watch to see that these three things happen:

- 1) Power light on your keyboard should light up
- 2) Apple should 'beep' at you as it normally does
- 3) You should see the "APPLE ][" prompt at top of the monitor

If all three of these things do not happen as they normally do then immediately **TURN OFF THE POWER TO YOUR APPLE** as something is wrong. Recheck everything to make sure nothing is obviously wrong and retry the power. Should you still have the same problem go read the next section on Installation 'Gotchas' or Troubleshooting in Appendix F. If you still can't figure out why it doesn't work contact your Dealer or Prometheus.

If everything works normally you are ready to put the lid back on your Apple and start checking out the VERSAcad. If you live in a different time zone than Pacific Standard Time then the time will be set wrong and you may want to proceed to Section 8.6.2 on how to set the time as you will need to change the position of the clock write protect switch.

Don't forget to hook the other ends of the cables up to your particular peripherals. !

### 3.2. Common Installation 'Gotchas'

If things don't seem to be working correctly or if you want to see if you've made any of the common installation mistakes read on ! Here is the list of common installation 'GOTCHAS' !

A. Setting the slot select switches for slot 0 (All ON) - Should you set the switches for slot 0 (that is switches 1-3 or 4-6 of S2), which is reserved for memory expansion either you're Apple will not power up correctly or things just don't seem to work properly.

B. Setting the slot select switch to a slot that is already occupied by another interface card - If you do this the interface in that physical slot and the interface on VERSACARD will not work properly, most probably not at all. The only exception to this is when the clock is phantom over a Z-80 type of card !

C. Parallel printer seems to miss characters - This happens when you have an improperly made cable or if the parallel printer disable switch is OFF for disable. If you do not intend to disable the parallel printer make sure that the printer disable switch is left ON.

D. Can't read or set the Real Time Clock - If you can't set the clock but can read it then you probably have forgotten about the clock write protect switch. If the clock write protect switch is enabled then you will never be able to SET the clock. It must be disabled.

The most common problem encountered when not able to read the clock is not using a Control D for Apple DOS when DOS is active and selecting the wrong slot. Remember that the slot for accessing the clock is not the physical slot that the VERSAcad is installed in but the phantom slot you have selected by the clock slot selection switches !

E. Serial port does not work correctly - This is almost always a cable problem. Remember that just because two devices are both RS-232 compatible does not mean that they will hook up together. Make sure that you have thoroughly read the installation section, especially on serial cables. Appendix G on Specific serial cables also tells how many of the more popular cables must be made. Also, check the baud rate.

F. Can't read the clock under CP/M and Apple Pascal - Read Section 4.3 as it describes this problem.

#### 4. Testing out the Interfaces

Now that everything seems to be installed properly, let's check out the interfaces one by one. Skip any section below that deals with a peripheral that you are not using.

##### 4.1. Serial and Parallel Interface

Lets start with the PARALLEL INTERFACE. Simply boot your Apple DOS 3.3 Master disk. Once you are in the BASIC monitor type PR#n where n is the slot number the parallel printer is phantomed. Your printer should do a carriage return and the Apple video monitor should display the Basic prompt character of > or ]. Should the prompt not reappear, make sure that all cables are hooked up correctly, that your printer is on line and that no other card is physically in the same slot that the VERSAcad parallel printer is phantomed. Should you still have trouble, start at the beginning of this installation section and make sure everything is properly connected and configured.

Try typing a few characters and then hitting the carriage return key. The characters will be printed on your printer and you will receive a SYNTAX ERROR from the Apple Basic monitor. This is because it did not recognize the characters you typed in as legal basic commands. To not receive this error use a ^X (control X) instead of the carriage return key.

To completely try out the parallel interface, use the program below. This program will continuously print out characters to your printer. When you hit your printer OFF LINE, the printing should stop. After putting the printer ON LINE, the printing should resume right where it left off. Should your printer have a buffer, it may continue printing for a while after you have put the printer OFF LINE.

```
5 D$=CHR$(4)
10 PRINT D$;"PR#n" :REM n IS THE PRINTER PHANTOM SLOT
20 FOR I=32 to 111
30 PRINT CHR$(I);
40 NEXT I:PRINT
50 GOTO 20
```

Fig. 4-1: Printer Checkout Program



Should you be hooking up a modem to the VERSAcards serial interface, we suggest that you use the "terminal" mode of operation on VERSAcards (terminal mode is discussed in section 8.5) or one of the modem programs available on the market that can use the serial interface with an RS-232C modem.

#### 4.2. Real Time Clock

Use the following program to read and test out the clock. Pick the one which reflects your current mode of operation.

| DOS ACTIVE          | DOS NOT ACTIVE<br>APPLESOFT | INTEGER BASIC            |
|---------------------|-----------------------------|--------------------------|
| 10 D\$=CHR\$(4)     | 10 PR#n                     | 10 DIM T\$(25)           |
| 20 PRINT D\$;"PR#n" | 20 IN#n                     | 20 D\$="D":REM CONTROL D |
| 30 PRINT D\$;"IN#n" | 30 INPUT "%";T\$            | 30 PRINT D\$;"PR#n"      |
| 40 INPUT "%";T\$    | 40 PR#0                     | 40 PRINT D\$;"IN#n"      |
| 50 PRINT D\$;"PR#0" | 50 IN#0                     | 50 INPUT ">";T\$         |
| 60 PRINT D\$;"IN#0" | 60 PRINT T\$                | 60 PRINT D\$;"PR#0"      |
| 70 PRINT T\$        |                             | 70 PRINT D\$;"IN#0"      |
|                     |                             | 80 PRINT T\$             |

Table 4-1: Real Time Clock Programs

You should get the current time such as: WED NOV 21 11:59:05 PM

The D\$ is necessary when running programs under Apple DOS. You must substitute "n" for the slot number the clock is phantom for. The time will be read in the AM/PM format as described in Section 8.6.1 of this manual. Should the time need to be reset, refer to Section 8.6.2 in the software section.

#### 4.3. Clock/Calendar Interfaces in CP/M and Apple Pascal

Neither CP/M nor Apple Pascal have standard interfaces to read the clock. Numerous different methods can be used to read the clock in Pascal and CP/M. A program to read the clock in MBASIC in CP/M is listed in Appendix H. A program is available to read the time and set the date in Apple Pascal from Prometheus. This program is part of the Applications and Diagnostics Disk.

#### 4.4. Interrupts

Interrupts are used for various applications from printer spooling to background/foreground processing. It should be emphasized here that apparently simple programs involving the use of interrupts can be quite complicated. A sample program that lists the time in MOUNTAIN HARDWARE format is listed in Appendix A. Please read completely Section 7.7 on interrupts and Appendix A.

#### 4.5. BSR Interface

The VERSAcad is capable of communicating with a BSR/X-10 ULTRASONIC COMMAND CONSOLE by means of the optional ultrasonic transducer. Once this ultrasonic transducer is connected (see installation portion of this manual) you can send commands to the COMMAND CONSOLE in much the same way that a TV remote control sends commands to the TV. In essence, the VERSAcad is a remote control unit to the BSR/X-10 COMMAND CONSOLE. The BSR interface has an entire section devoted to its use and checkout. Please refer to Section 9 for further checkout.

### 5. SERIAL INTERFACE HARDWARE

#### 5.1. General Information

The serial interface on VERSAcad is an RS-232C interface with hardware handshaking capability. The serial interface hardware is compatible with the Apple Communications Card and contains the same signature bytes as the Communications card so that different software packages can find and use the serial interface as if it were an Apple Communications Card.

The serial port on VERSAcad is configured as DTE (Data Terminal Equipment). Connection is made to an external peripheral via connector J2.

J2 PIN OUT:

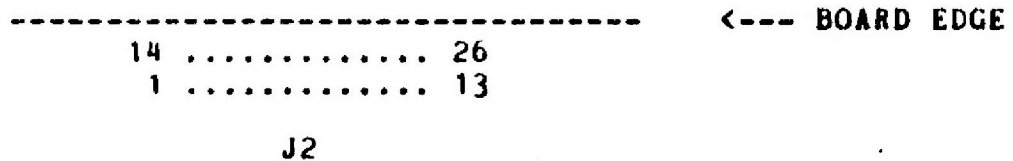

Fig. 5-1: J2 (serial port) pinout numbering

The above pin numbers also reflect the pin numbers that are on the female "D" type connector, where the peripheral will actually connect. This assumes that a straight through cable is being used. Many cables have certain RS-232 signals moved internally in the cable so that it will hook up to the peripheral correctly. In this case you would need to know what changes have been made so that you can identify which signal appears on which physical pin on the connector.

Each pin is driven by a RS-232C driver chip that conforms to the levels needed to communicate with standard serial devices. Each pin that receives data from the interface is terminated into a RS-232C compatible receiver. No other special interface circuitry is needed.

### 5.1.1. Current Loop and Teletypes

The VERSAcad is RS-232 compatible and is NOT current loop compatible. Many users assume that any RS-232 device will work correctly with a current loop type of interface. NOT SO ! If you have a current loop type of interface or an old teletype which you are using for a printer ( Many old teletypes are current loop interfaces, though some are RS-232 compatible ) you will need to obtain an current loop to RS-232 converter before you can hook it up to the VERSAcad serial interface.

### 5.2. RS-232C Pin Descriptions

The RS-232C standard has many more lines than are used by VERSAcad. Out of 25 lines of the interface, VERSAcad uses 5 for signals and 2 for ground. With these lines, however, most if not all, of the applications for serial communication can be accommodated if the following conditions are met.

| PIN # | CIRCUIT | DESCRIPTION         | DIRECTION      |
|-------|---------|---------------------|----------------|
| 1     | AA      | Protective Ground   |                |
| 2     | BA      | Transmitted Data    | From VERSAcad  |
| 3     | BB      | Received Data       | To VERSAcad    |
| 4     | CA      | Request to Send     | From VERSAcad  |
| 5     | CB      | Clear to Send       | To VERSAcad    |
| 6     | CC      | Data Set Ready      | To VERSAcad    |
| 7     | AB      | Signal Ground       | Apple Ground   |
| 8     | CF      | Data Carrier Detect | ( no connect ) |
| 9-19  |         | ( pins not used )   | ( no connect ) |
| 20    | CD      | Data Terminal Ready | From VERSAcad  |
| 21-26 |         | ( pins not used )   | ( no connect ) |

Table 5-1: VERSAcad RS-232 pinout definitions

PIN 2 (TXD) - Data that you want to be sent out of the Apple to a terminal, printer, modem or other serial device appears on PIN 2 of VERSAcad's serial connector, J2.

PIN 3 (RXD) - Data sent from the attached peripheral that is to enter the Apple for processing enters PIN 3 of J2.

PIN 4 (RTS) - This output from VERSAcad, when in its true state, indicates to the attached device that the serial interface on VERSAcad is powered up, initialized and ready to send data out PIN 2 to the device. That is to say, when this pin has more than 3 volts on it, VERSAcad is ready to send data.

PIN 5 (CTS) - This input to VERSAcad indicates that the attached device is ready to receive data transmitted to it on PIN 2 of VERSAcad's serial interface. If PIN 5 is in its false state (< -3 volts) then VERSAcad will not send any data out PIN 2 until it sees PIN 5 true. This is the pin that should be connected to the device's READY line, since it inhibits the transmission of data to the device when it is busy. VERSAcad will wait for the device to go ready again before sending any further data to the device, thereby preventing lost or missing characters.

Pin 5 on the VERSAcad is pulled high by a resistor. When no serial cable is connected to the VERSAcad or if pin 5 is left unconnected pin 5 will be high. The 6850 UART (the 6850 is the chip on the VERSAcad that does all of the receiving and sending) will assume that it is OK to send data.

Incorrect application of this pin may cause the device to work correctly when a simple sending test is tried, but when devices such as a printer are hooked up at higher baud rates data may be lost (typically the buffer is overrun). As stated before Pin 5 is usually tied to the busy line (sometimes called reverse channel) on peripherals such as printers.

PIN 6 (DSR) - This input to VERSAcad, when logically true, indicates that the device is powered up and ready to send data to VERSAcad on PIN 3. If this pin is low, then the receiver on VERSAcad will not respond to data on PIN 3, even when data is being sent by the device and all other signals are true. However, the natural state of this pin is true, so not connecting PIN 6 to your device (or any other point) is OK and VERSAcad will respond normally.

PIN 8 (DCD) - Pin 8 of the RS-232C connector (Figure 1) is DCD - Data Carrier Detect. It is provided by a communications device to indicate the presence of a communications carrier. If this signal is low (0 volts), then that indicates to the serial port that the serial link is not established, and data will not be sent. The serial port on VERSAcad does not use this signal directly since some modems still send back data when no carrier is present (i.e.-Hayes Smartmodem - If VERSAcad responded to this signal, it would not be able to receive status back from the modem when no carrier was present.) . To tie this pin high (logic 1), tie it to pin 20 on the interface (DTR which is high when power is on).

PIN 20 (DTR) - This pin is an output from VERSAcad that is always logically true as long as power is applied to the Apple and can be used to tie other pins high on both VERSAcad and the attached device, if needed.

PINS 1 and 7 (GND) - These pins are the ground pins for the serial interface and provide the return path for the various signals on both VERSAcad and the device. PIN 7 is signal ground and PIN 1 is the frame or equipment ground.

### 5.3. Serial Port Data Format

The data format on the VERSAcards serial interface is 1 start bit, 2 stop bits, 8 Data bits, and no parity. Incorrect data format is usually indicated by PARITY, FRAMING, or OVERFLOW ERROR. The Apple cannot indicate this type of error but the device you are sending to may be able to. If you do get this type of error find out what type of data format your peripheral expects. The data format can be changed by writing a byte of data to the serial port status port. The necessary information to read/write to the status port is contained in the Motorola 6850 (the 6850 is the serial interface chip that is used on VERSAcards) data sheet. Please refer to this data sheet for complete information. The status port location for the serial port is shown in Appendix B.

A simplified description of the 6850 UART chip is provided in Appendix D. Please refer to it should you need to modify the Serial Port Data Format.

### 5.4. Slot Selection

The Serial Interface is NOT selected by any switches since it is not a phantom interface. The serial interface shows up in the slot where the VERSAcards is physically inserted. The installation section of this manual gives many suggestions as to where to put the VERSAcards.

## 6. PARALLEL PRINTER INTERFACE HARDWARE

### 6.1. General Information

The parallel printer interface comes from the factory configured for a standard CENTRONICS type of printer interface. The cable attaches to the connector marked J3 on the board, with the cable running towards the top of the board. The signals and pin out of VERSAcards are listed as follows:

| J3 REV E         | J3 REV A-D | CENTRONICS PIN# | SIGNAL DESCRIPTION |
|------------------|------------|-----------------|--------------------|
| 2-20 (even pins) | 1,20       | 16              | Ground             |
| 19               | 2          | 10              | Acknowledge        |
| 1                | 8          | 1               | Strobe             |
| 3                | 10         | 2               | Data bit 0         |
| 5                | 11         | 3               | Data bit 1         |
| 7                | 12         | 4               | Data bit 2         |
| 9                | 13         | 5               | Data bit 3         |
| 11               | 14         | 6               | Data bit 4         |
| 13               | 15         | 7               | Data bit 5         |
| 15               | 16         | 8               | Data bit 6         |
| 17               | 17         | 9               | Data bit 7         |
| N.C.             | N.C.       | 11              | Busy               |

Fig. 6-1: J3 - Parallel Interface Pin Descriptions

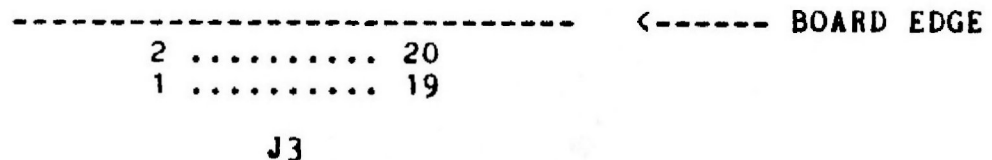

Fig. 6-2: J3 Pinout numbering

Data bits 0 thru 7 can also be referenced as bits 1 thru 8. Centronics pin 11, the busy line, is not connected to any input on VERSAcards. It is only included for reference, if this is the only handshake line your printer has.

The above Centronics pin numbers are the same numbers that are found on the connector plug at the printer end of the cable. A compatible connector is the Amphenol # 57-30360 36-pin male microribbon connector (or equivalent). This cable may be made by attaching a six-foot length of 20 conductor flat cable to a 20 pin header connector (J3 end), and soldering the Amphenol connector to the appropriate pin numbers on the other end. This cable is also available from your dealer or Prometheus directly.

\*\*\* See Section 2.4.2 for info on parallel cables \*\*\*

The signal levels sent and received by VERSAcad are standard TTL level signals, and require no special intermediate circuitry such as pull-up or pull-downs to operate with most printers.

## 6.2. Parallel Printer Interface Disable Switch

Two items must be done to fully disable the parallel printer interface. First to disable the on board firmware ROM the parallel printer interface phantom slot selection switches (See below and Appendix I.) must be set to the same slot that the VERSAcad is physically in. For instance, if the VERSAcad was physically inserted into Slot 5 then the switches on S1 that select the printer interface would have to be set for slot 5.

The second item needed to fully disable the printer interface is the setting of switch bank S2 switch position 1. Switch 1 of Switch Bank S2 is used to disable the printer busy circuitry. This must be done when disabling the parallel port or using the port as output only, but not connected to a printer. Setting this switch to OFF position disables the busy circuits, but not the strobe circuitry. Normal setting of this switch is the ON position. If this switch is in the OFF position when a printer is connected, the printer will miss characters or data sent to it since the data sent out the parallel port is sent as fast as the computer can send it.

### Slot Selection

Switches 1, 2 & 3 of switch S1 select the logical slot number for the printer function on VERSAcad. Valid slot numbers are 1 thru 7 inclusive. Slot 0 (all switches on) is not a valid slot, and the switches should not be set to this value. See Appendix I for complete details on switch settings. Also, reference the installation section of this manual for suggestions on switch settings.

## 7. CLOCK/BSR HARDWARE

### 7.1. General Information

There are 5 hardware features that are of concern to the user of the Clock/BSR section of the VERSAcad. These are the batteries, the trimmer cap, the clock write enable switch, the connection for an ultrasonic transducer and slot selection.

### 7.2. Slot Selection

The Clock and BSR control reside in the same slot. Actually, only the firmware is selected when the phantom switches are set for the Clock/BSR. The actual hardware registers used to read and set the Clock and the BSR control port reside in the device select space of the VERSAcad serial interface port. Doing this allows the user to phantom the Clock/BSR over a Z-80 (ALS 2-Card or Microsoft Softcard) type of card with no resulting conflicts. This allows the user to gain one physical slot without loss of software compatibility.

The Clock/BSR interface is a phantom interface. The phantom slot is set by switch bank S1 switches 4-6. For complete information on setting the Clock/BSR phantom switches see Appendix B and refer to the installation section of this manual for further suggestions.

### 7.3. Clock Write-Protect Switch

After the clock has been adjusted for the required accuracy and the correct time set, the time can be protected from accidentally changing it. Switch 6 on S2 accomplishes this task. The user can set the time when S2-6 is in the ON position. After the correct time is set, switch S2-6 can be turned OFF to disable any further write commands to the clock chip, thereby protecting the correct time. The only other thing that could change the correct time would be the removal of the batteries.

### 7.4. Batteries

The two batteries used on VERSAcad are "N" type. The type of batteries that should be inserted into the holders are Eveready type #E90 heavy-duty alkaline batteries (NEDA 910A) Current drain is very low ( $< 50\mu\text{A}$ ) and as a result, the batteries should be good for over 2 years. Replace when the clock becomes inaccurate or unreliable in use.

### 7.5. Trimmer Adjustment - Time Accuracy

Accuracy of the clock is adjusted by means of the adjustment capacitor (labeled VC1 on the card diagram and on the card) located above and to the right of integrated circuit chip U24, the clock chip. Adjustment is achieved by turning the small slotted metal shaft on top of the device either clockwise or counterclockwise as needed. The 12 o'clock position and the six



o'clock position are the extremes in speed adjustment for the clock. Adjust slightly and then check time measurement.

An accurate time source such as WWV on shortwave radio or the phone company time can be used to set and check the Clock for accuracy. Also, over periods of greater than 24 hours, digital home clocks are very accurate. Alternatively, a frequency counter can be used to set the frequency present at pin 17 of U24 to exactly 32,768 Hertz. Adjust the trimmer set-screw for the correct reading. This is the method that the factory uses to adjust each card as a part of final burn-in before shipment.

#### 7.6. BSR Connector - J4

An ultrasonic transducer can be attached to VERSAcad for BSR/X-10 wireless remote control via connector J4. The firmware and transducer are available as an option from the factory or your local computer store. The transducer connects to VERSAcad via the 2 pin header labeled J4. The pin near the edge of the board is a ground pin while the pin inboard from that is the signal pin. This connector can also be used as an output to an external device. The signal level is from 0 to 12 volts and is negative true logic.

#### 7.7. Interrupts

There are 3 interrupt rates that can be selected on VERSAcad. They are 1024 per second, 1 every second, 1 every minute. The interrupt rates are hardware selectable and are selected by jumper matrix JH1 found in-between the batteries.

```
. . <----- 1 interrupt per minute  
. . <----- 1 interrupt per second  
. . <----- 1024 interrupts per second
```

JH1

Fig. 7-1: JH1 - Interrupt Rate Selection

Jumper J1, found right above the Apple 50 Pin connector, allows you to physically jumper the interrupt line to the Apple bus. J1 is not the same jumper as JH1 so do not confuse them. If J1 is open (normally jumpered closed), no interrupts will ever occur.

\*\*\*\* CAUTION - Interrupts are very useful but need to be carefully implemented. There are possible problems when running Apple DOS and certain restrictions when running with VERSAcad. Please read this section carefully before implementing interrupts. \*\*\*\*

### 7.7.1. Problems with Interrupts

PAGE 0 LOCATION \$45 - When running under Apple DOS, there is a problem with location \$45 hex in page zero of the Apple. Both the Apple FB monitor ROM and certain routines in Apple DOS expect exclusive use of location \$45 for storage. Should an interrupt occur while executing a DOS command that uses location \$45 for intermediate results, you may receive such errors as RANGE ERROR, SYNTAX ERROR or worse things such as destroying the current disk that you are using. If an interrupt does occur when DOS is using location \$45, DOS always loses. Remember that any command that starts with a Control D (^D) is interpreted as a DOS command.

The simplest way, though cumbersome, to solve this problem is to disable interrupts when executing a DOS command and then enable them when done. This can be done through the use of CALL statement from BASIC. This is further explained later in this section.

### 7.7.2. Interaction with VERSAcad Firmware

The firmware on VERSAcad is fully interruptable. Some caution needs to be exercised when running interrupts and when using the VERSAcad printer port. The firmware on VERSAcad disables interrupts on any critical stack operations so as to maintain program integrity. The interrupt status of the processor and of VERSAcad are saved when the routine is entered and is put back the same way when exiting the critical sections of the firmware. For example, if interrupts are enabled when the routine is entered, they will be disabled when the routine executes and re-enabled upon exit. If they are disabled, they remain disabled upon exit.

### 7.7.3. Enabling and Disabling Interrupts

The VERSAcad interrupt control bit is mapped into the same space as the clock control ports. These control ports are found in the device select space of the slot that VERSAcad occupies (the slot the serial port is set to). The hex address is C082 + n0 where n is the slot number. For example, if you were in Slot 3 the address would be C0B2 or C082 + 30 hex (n=3). The interrupt control bit is bit 5. When enabling or disabling interrupts the lower 5 bits (bits 0 thru 4) should be all 1's. See FIGURE 7-1 below and Appendix B.

```
LDA #$1F      :LOAD ACC WITH 1F HEX
STA $C082,X   :X CONTAINS SLOT # AS n0
              (your routine goes here)
LDA #$5F      :LOAD ACC WITH 5F HEX
STA $C082,X   :SAVE X IF YOU USE IT IN YOUR CODE
LDA $45       :RESTORE ACC VALUE BEFORE INTERRUPT
RTI
```

Table 7-1: Sample interrupt service routine

When bit 6 (0-7) is a 1 interrupts are enabled and when it is a 0 interrupts are disabled and reset. Besides interrupts being enabled the Clock chip must be put into interrupt mode. This is done by writing a 1F (hex) to the lower 5 bits of C082 + N0. In other words to disable interrupts write out a 1F (hex) and to enable interrupts write out a 5F (hex). Remember that interrupts need to be enabled or disabled on the processor. The interrupts on VERSAcards are latched by U27 when they occur so that no interrupts can be lost. Loading a 1F hex to the control register resets this latch as well as disabling interrupts. This should be done every pass through the service routine as shown above in figure D-1. The status of the on-board interrupt enable control bit can be read back as bit 5 of the read register at \$C083 + n0. This is useful in polling VERSAcards during service routines to determine the interrupt source. The code example in Appendix A will write the time in the upper right hand corner of the Apple screen every interrupt.

## 8. Software

### 8.1. General Comments

The firmware for VERSAcad is contained within an industry standard 2716 EPROM. No configuration disks are needed to set the VERSAcad for operation. An Applications and Diagnostics disk is available as an option which contains many useful programs (such as the one in Appendix A. ) that have been written to help you utilize the clock/calendar and other features of the VERSAcad. The sections under SERIAL/PARALLEL/CLOCK and BSR describe the software options available for each function. Refer to the appropriate section for complete information.

The major options you will use will be with the Serial and Parallel Ports. The firmware initializes each of the functions to default conditions. These conditions are set to allow compatibility with most peripheral devices. Table 8-1 lists the default conditions for the Serial and Parallel Ports for quick reference.

| OPTIONS                   | SERIAL | PARALLEL | COMMENTS                                       |
|---------------------------|--------|----------|--|
| AUTO LF                   | ON     | ON       | Disable LF after CR on your printer            |
| 8TH Bit (MSB)             | Clear  | Clear    | 8th bit always 0, can be set to 1 for graphics |
| Apple Video               | ON     | ON       | Output shows up on Apple screen also           |
| Paging                    | OFF    | OFF      | Prints 60 lines before a Form Feed occurs      |
| Graphics                  | OFF    | OFF      | Output unmodified 8 bits of data.              |
| DEFAULT control character | ^I     | ^I       |  |

Table 8-1: Firmware Options for Serial and Parallel Ports

These conditions are set to their default values when output is first invoked. Output/Input is invoked by the PR#n/IN#n from BASIC or n^P/n^K from the monitor, where "n" is the slot number. A call from assembly language to Cn00 (hex) will also initialize the peripheral driver to its default conditions. The normal Input/Output entry points to each device driver are defined in their respective software sections.

To change the default setting upon initialization please refer to Appendix C.

## 8.2. Serial and Parallel Firmware Commands

The firmware for the serial and parallel drivers was designed so that most peripheral devices are easily interfaced. Whatever slot the Serial or Parallel Port is configured for is the slot the software drivers reside in. In the Apple memory map this driver would show up at Cn00 (hex) where n is the slot number that the peripheral port is in. VERSAcards utilize the C800 memory space of the Apple. Therefore, the Serial Port firmware always shows up at C800 (hex) and the parallel firmware at C900. Additional sections of the drivers reside at various other locations throughout the C800 space.

|                                   | <u>SERIAL</u><br>X-SERIAL<br>SLOT | <u>PARALLEL</u><br>Y-PARALLEL<br>SLOT | <u>CLOCK</u><br>Z-CLOCK<br>SLOT |
|-----------------------------------|-----------------------------------|---------------------------------------|---------------------------------|
| CARD SLOT<br>MEMORY               | CX00-<br>CXFF                     | CY00-<br>CYFF                         | CZ00-<br>CZFF                   |
| PERIPHERAL<br>EXPANSION<br>MEMORY | C800-<br>C8FF                     | C900-<br>C9FF                         | CA00-<br>CAFF                   |
|                                   |                                   |                                       | CB00-<br>CFFF                   |

Fig. 8-1: VERSAcards Memory Map

### CHARACTER

### CORRESPONDING ACTION

|    |   |
|----|---|
| E  | Enable auto line feed - DEFAULT               |
| K  | Disable auto line feed after CR               |
| V  | Enable video output to Apple screen - DEFAULT |
| O  | Disable video output to Apple screen          |
| C  | Clear 8th bit of output data byte - DEFAULT   |
| S  | Set 8th bit of output data byte               |
| T  | Enter terminal mode of operation              |
| P  | Paging ON                                     |
| N  | Paging OFF - DEFAULT                          |
| G  | Graphics - On only                            |
| ^x | Change lead-in character to ^x - SEE BELOW    |

Table 8-2: Firmware Command Definitions

Table 8-2 lists the firmware options available for the Serial and Parallel drivers. To modify the options to values other than the default values, a command sequence must be sent. VERSAcards interpret a ^I (this is the CNTRL button held down while the I key is pressed - CNTRL I) as the default command sequence lead-in character. That is to say, if a ^I is sent to the firmware driver, the character immediately following the

control character will perform the corresponding action. Table 8-2 lists the valid command characters and their meanings. These command characters must be prefaced by the current valid lead-in character (default is ^I).

**CHANGING LEAD-IN CHARACTERS** - The lead-in character can be changed by typing in any other control character after the current lead-in character. The default lead-in character is ^I. Should you, for example, want to change the lead-in character to a ^K you would send to the VERSAcad driver a ^I^K. Now the current lead-in character is a ^K. Don't type ^I RETURN or ^I^M or the RETURN key will become the lead-in character.

**AUTO LINEFEED** - VERSAcad inserts a LINEFEED character automatically after every CARRIAGE RETURN character sent to it if this option is enabled. For proper operation of the printer connected to VERSAcad the AUTO LINEFEED setting in the printer should be set to OFF, if so equipped.

**VIDEO OUTPUT** - This option produces simultaneous output on the Apple's video monitor when data is being sent to the selected output device.

**8TH BIT** - The most significant bit (data bit 7 for bits 0-7 or data bit 8 for bits 1-8) can be set or cleared to allow use with printers that support graphics. For example, if the 8th bit is cleared, all data sent out will have its MSB set to a 0.

**LINE LENGTH** - The line length is set in the same method that the Apple Parallel Printer Card uses. This is done to maintain compatibility with existing software that uses these control sequences. To set the Line length the current lead in character is issued (default is a ^I) followed by the line length in decimal (from 1 to 255) followed by the capital letter N.

Ex. Set line to 80 characters     ^I80N <cr>  
Set line to 27 characters     ^I27N <cr>  
Set line to 219 characters    ^I219N <cr>

Any decimal number from 1 to 255 can be used. The default setting is 255 characters. When line lengths of more than 40 characters are set, the video output is turned OFF. When line lengths of less than 41 characters, the video output is turned ON. The line length default value is 255 (FF hex) to accommodate printers with carriage width of more than 40 characters. Upon initialization (the device is initialized any time a PR#n is done) the video is set to ON even though the line width is greater than 40 characters. This is done so that the beginning user does not think the interface has gone "south" when he sees nothing being echoed on the video screen. The video can be turned OFF by the use of the ^IO <cr> command (Table 8-2). Any use of the ^I80N format type of command will effect the video as described above.

Remember that the Apple video out routine will insert a line feed after the 40th column (the end of the video screen) if video is on and this will be sent to the printer. This is only for BASIC listings. The net effect is that you can only print in 40 columns even if you have the line length set greater. Turn off the video should you only be able to print in 40 columns.

**PAGE LINES** - Lines Per Page is set in exactly the same manner as the line width except that the ending character is a capital L.

Ex. Set Lines per page to 35 lines            <sup>^</sup>I35L <cr>  
Set Lines per page to 210 lines           <sup>^</sup>I210 <cr>

Paging does not go into effect until paging mode is turned on.

**DELAY AFTER CARRIAGE RETURN** - Again, delay after carriage return is set the same way as lines per page and line width. The ending character is a capital D.

Ex. Set delay for 23                    <sup>^</sup>I23D <cr>  
Set delay for 187                    <sup>^</sup>I187D <cr>

A small number sets a small delay and a large number sets a large delay. The default is set small to 3.

Remember that if these special commands are issued directly from the Basic interpreter that you will receive a SYNTAX ERROR even though the command was recognized by the VERSAcad, if you terminate the control sequence with a carriage return. Use a <sup>^</sup>X instead of a carriage return and the SYNTAX ERROR message will be eliminated.

**GRAPHICS MODE** - Every 255 characters (maximum dependent on line length set) a carriage return is issued. When outputting graphics, this may be undesirable. To output a full 8 bits of data while turning OFF all other functions in VERSAcad's driver, turn ON the graphics mode. This is done by issuing a <sup>^</sup>IG. Once this is done the firmware will no longer respond to any control sequences, and must be exited by using a PR#0 or O<sup>^</sup>P. To start normal output to VERSAcad re-initialize using PR#n or n<sup>^</sup>P commands.

### 8.3. Software considerations when using Apple Pascal and CP/M

The firmware drivers for the serial and parallel sections of VERSAcad have their default options set to operate with the most common printers, terminals and operating systems.

To operate a printer correctly under CP/M, Apple Pascal, and Apple DOS your printer's AUTO LF switch should be set to OFF. CP/M and Apple Pascal do not use the firmware driver on the VERSAcad but utilize only the hardware. The CP/M and Apple Pascal drivers insert their own LF's after CR. If you have AUTO

LF enabled on your printer then you will have 2 line feeds per CR. The AUTO LF option on VERSAcards is enabled since most Apple software that calls the firmware on the VERSAcards does not generate an LF after CR. Should your printer linefeed twice when operating under Apple DOS disable the AUTO LF option in VERSAcards's firmware.

Neither CP/M or PASCAL has standard interfaces to Real Time Clocks or BSK control interfaces. A program to read the clock in MBASIC under CP/M is included in Appendix H. A disk to read the time and set the date in Apple Pascal is available as part of the Applications and Diagnostics disk. (optional)

#### 8.4. Other Software and Hardware Considerations

When using an external terminal with the VERSAcards Serial Port, the AUTO LINE FEED on the terminal should be turned OFF. Should the terminal be receiving an extra line feed and there is no way to turn OFF the line feed function on your terminal, disable the auto line feed on the VERSAcards.

The 8th bit of the data being output is used to control the graphics features of most popular printers. The default condition of the 8th bit is clear (0) so that normal printing will occur. The user can set the 8th bit so that graphics can be printed under software control with the VERSAcards.

Paging has been implemented on the VERSAcards so that printing on or over the perforations on computer paper does not occur. The default condition is disabled so that a user's program can supply paging information. The form length is set for standard eleven inch paper. Make sure the printer is at top of form when output is initialized.

#### 8.5. Terminal Mode

Terminal mode offers the user a way of communicating with an external computer via an RS-232C modem. When in Terminal Mode the Apple keyboard and video screen act as a "terminal" to the modem. No communication with the Apple monitor or disks can be done. All characters received by the modem and sent to the VERSAcards serial port are echoed on the Apple screen. All characters are passed to the screen with the exception of Line Feed. Line feeds are ignored because the Apple monitor inserts a line feed automatically after CR. Terminal mode also converts all lower case characters into upper case. This is done since the Apple cannot display lower case characters.

Terminal Mode supports Half/Full duplex and can print characters received by the serial port to the VERSAcards parallel Printer Port. The following is a list of the commands that can be used when in Terminal Mode. No lead-in character is necessary as in the standard operating mode. These control sequences work only in Terminal Mode.



| Control Character | Command Action                        |
|-------------------|---------------------------------------|
| <b>^P</b>         | Turns ON or OFF output to the printer |
| <b>^D</b>         | Turns ON or OFF full duplex           |
| <b>^R</b>         | Exits Terminal Mode                   |
| <b>^B</b>         | Sends a software break                |

**\* - Printer (only VERSAcad) must be set for slot 1 - \***

**Table 8-3: Terminal Mode Command Characters**

The default condition for the printer is OFF and the default condition for Full Duplex is OFF. Typing the control command the first time will turn on the option, typing the command the second time will turn OFF the option, and so on.

When using the printer, the parallel printer port **MUST** be assigned to slot 1 or the Apple will "hang" when output is sent to the printer.

To use terminal mode you must first hook up your modem to the VERSAcad RS-232C port. Most modems run at 300 baud so make sure the baud rate is set right. For more complete information on hooking up a modem to VERSAcad see Appendix G.

After the modem is connected you should initialize output to the serial port with the n^P or PR#n commands (n is the slot number of VERSAcad). You will receive a standard response as if it were a terminal but printing on the Apple screen will occur much slower since you are running at 300 baud. To enter Terminal Mode type ^IT, which is the command sequence to enter Terminal Mode from the Serial Driver. When terminal mode is entered the Apple video screen will clear and a "-" sign will appear as the initial prompt.

Once in Terminal Mode your Apple responds as if it were a terminal. Try typing a few characters or commands to your modem. If your modem or external computer is echoing characters you need to use the ^D command to change from HALF to FULL duplex. Terminal mode will now echo characters for you. If you are getting more than one character echoed use the ^D command to change duplex modes. Now only one character will be echoed. The only thing that HALF duplex does for you is echo characters should your external computer not do so. When in FULL duplex, characters are not echoed by Terminal Mode.

Terminal Mode does support a cursor. The only editing feature is the destructive backspace. The backspace will work correctly when issued either from the Apple keyboard or from the external computer. If a line feed only is generated by the external computer or from the Apple key board (by pressing ^J) a line feed will be generated but will leave a flashing square at

the end of the last line. The Apple COUT routine which Terminal Mode uses issues its own line feed when the column length is exceeded so no line feeds are necessary to be sent and will have the results as described.

Should you desire to have something received by the VERSAcad Serial Port printed to the printer port, use the ^P command. This will turn ON the printer if it was currently OFF. If the printer is currently active and you want to turn it off, type the ^P command again and printing will stop. Only input to the Serial Port from the modem will be printed and not characters typed on the Apple keyboard. Printing may be turned ON or OFF while characters are being received from the modem.

Many computers cannot be interrupted when sending information to your Apple except by a 'break'. When a ^B is typed during Terminal Mode a break is issued by the Serial Interface. This will interrupt most host computers and put them back in the Command Mode.

When done with Terminal Mode use the ^R command to exit back to the Serial Driver.

## 8.6. Clock Firmware

The Real Time Clock in the VERSAcad emulates the firmware of the THUNDERWARE RTC/BSR control card. This firmware allows the user to display clock information in various formats including MOUNTAIN HARDWARE format. Interface to the firmware is accomplished by the conventional Apple PR# and IN# commands. If the user desires he can interface to the Real Time Clock through assembly language. Please reference Section 8.6.4.

It should be noted here that although the firmware of the RTC was designed to emulate the THUNDERCLOCK card it does not mean that all software that will work with the THUNDERCLOCK will work with the VERSAcad. The VERSAcad is designed differently and any packages that directly address the hardware (especially interrupts) will not work with the VERSAcad.

### 8.6.1. Input/Output Mode Characters

There are 7 basic mode characters that the RTC interprets to display the time in different formats. These mode characters are shown in TABLE 8-4.

| Character: | Format type: | Called From:  | Example                |
|------------|--------------|---------------|------------------------|
| %          | AM/PM 12 hr  | Applesoft     | SAT FEB 09 10:23:55 PM |
| >          | AM/PM 12 HR  | Integer BASIC | SAT FEB 09 10:23:55 PM |
| &          | 24 HR FORMAT | Applesoft     | SAT FEB 09 10:23:55    |
| <          | 24 HR FORMAT | Integer BASIC | SAT FEB 09 10:23:55    |

|     |                 |              |                    |
|-----|-----------------|--------------|--------------------|
| " " | MOUNTAIN FORMAT | EITHER BASIC | 02/09 22;23;55.000 |
| #   | NUMERIC FORMAT  | EITHER BASIC | SEE BELOW          |
| /   | READ YEAR       | EITHER BASIC | 1982               |

**Table 8-4: Real Time Clock Mode Characters**

The ">" and "<" ASCII characters display the time in 12 hour AM/PM format. Which character is used by your program depends on whether the program is in APPLESOFT or INTEGER BASIC. The "&" and "<" are used to display the time in 24 hour format. Again, the different characters are used to differentiate between Integer and Applesoft BASIC.

The " " (the quotes are shown to indicate an ASCII space) is used to display the time in MOUNTAIN HARDWARE Apple Clock format. If no mode character has been given to the RTC then MOUNTAIN HARDWARE format is assumed. This is done to maintain compatibility with MOUNTAIN HARDWARE time access programs. The RTC will default to MOUNTAIN format after every reading of the clock. The user program must reset the mode character every time the clock is to be read.

The "#" character is used to read the time in the numeric value format. This format allows the time to be easily manipulated under program control.

The numeric value format returns the time as a series of integer values. The following BASIC statements would read the time in numeric format.

```
INPUT "#";MO,DA,DT,HR,MN,SC (Applesoft BASIC)
```

```
INPUT "#",MO,DA,DT,HR,MN,SC (Integer BASIC)
```

WHERE:

```
MO = Values 1 to 12 for JAN (1) to DEC (12)
DA = Values 0 to 6 for Day of Week; 0=SUN 6=SAT
DT = Values 0 to 31 for Day of Month
HR = Values 0 to 23 for Hour 1=1AM,12=NOON,15=3PM,00=MIDNIGHT
MN = Values 0 to 59 for Minutes
SC = Values 0 to 59 for Seconds
```

### 8.6.2. Reading and setting the time

Use the following programs to read the time in BASIC. Remember that you need to use a control D for DOS if you are using Apple DOS. There are no standard routines to read the time in CP/M and Apple Pascal. More information on this subject is covered in the installation section of this manual.

| DOS ACTIVE          | DOS NOT ACTIVE   | INTEGER BASIC       |
|---------------------|------------------|---------------------|
| 10 D\$=CHR\$(4)     | 10 PR#n          | 10 DIM T\$(25)      |
| 20 PRINT D\$;"PR#n" | 20 IN#n          | 20 D\$="^D"         |
| 30 PHINT D\$;"IN#n" | 30 INPUT "%";T\$ | 30 PRINT D\$;"PR#n" |
| 40 INPUT "1";T\$    | 40 PR#0          | 40 PRINT D\$;"IN#n" |
| 50 PRINT D\$;"PR#0" | 50 IN#0          | 50 INPUT ">";T\$    |
| 60 PRINT D\$;"IN#0" | 60 PRINT T\$     | 60 PRINT D\$;"PR#0" |
| 70 PRINT T\$        |                  | 70 PRINT D\$;"IN#0" |
|                     |                  | 80 PRINT T\$        |

**Table 8-5: Programs to read the Real Time Clock**

The time is set by printing a special mode character to the RTC before giving it the time sequence. This special character is the "!" mark. The format of the time string that follows the "!" is as follows:

!MM W DD HH MM <return>

Where:

- MM Two ascii digits 01-12 where 01=JAN and 12=DEC
- W One digit 0-6 for Day of week 0=SUN 6=SAT
- DD Two Ascii digits for date 01 to 31
- HH Two Ascii digits for hours 00-23 where 01=1 AM, 12=noon, 14=2 PM and 00=Midnight
- MM To digits 00-59 defining the minute

The following program can be used to set the time on the VERSAcad. REMEMBER TO DISABLE THE CLOCK WRITE PROTECT SWITCH (SECTION 7.3) BEFORE SETTING THE TIME.

```

10 D$=CHR$(4)           : REM THIS IS ONLY USED WHEN DOS IS ACTIVE
15 PRINT "REMEMBER TO SET WRITE PROTECT SWITCH TO OFF"
20 PRINT D$;"PR#n"     : REM n IS THE SLOT THE CLOCK IS SET FOR
30 PRINT "!11 6 21 14 59 00": REM SETS CLOCK FOR SAT NOV 21 02:59:00 PM
40 PRINT D$;"PR#0"     : REM SETS OUTPUT BACK TO APPLE VIDEO
50 PRINT " TIME SET - RESET WRITE PROTECT SWITCH"

```

**Table 8-6: Program to set the Real Time Clock**

### 8.6.3. Reading and setting the year

The year is read in the same way as the time (see Section 8.6.2). A mode character needs to be sent to the Clock and then the year is read back. The year can be read back as either a string or integer variable. The following example can be used from either Applesoft or Integer BASIC. Remember to dimension string variables in Integer BASIC.

#### DOS NOT ACTIVE

```
10 PR#n
20 IN#n
30 INPUT "/" ;T$
35 INPUT "/" ;G
40 PR#0
50 IN#0
60 PRINT T$
70 PRINT G
```

#### DOS ACTIVE

```
10 D$=CHR$(4)
20 PRINT D$;"PR#n"
30 PRINT D$;"IN#n"
35 INPUT "/" ;G
40 INPUT "/" ;T$
50 PRINT D$;"PR#0"
60 PRINT D$;"IN#0"
70 PRINT T$
80 PRINT G
```

Table 8-7: Programs to read the year

Example: Returned value of both T\$ and G would be 1982

n=slot number the clock is phantom for. The ";" in line 30 (DOS not active) or line 40 must be changed to a "," when running the program from Integer Basic.

To maintain software compatibility with THUNDERCLOCK time setting routines, the standard routine has not been changed. Should you need to reset the year use the following Basic program. Make sure the clock write protect switch is OFF.

```
5 VM=49283
10 HOME
20 INPUT "YEAR IS 19";YR$
30 INPUT "SLOT WHERE VERSACARD IS PHYSICALLY LOCATED - ";VC
40 VC=VC*16
50 POKE VM+VC,ASC(RIGHT$(YR$,1))-48
60 POKE VM-1+VC,11
70 POKE VM-1+VC,43
80 POKE VM-1+VC,11 :REM STROBE IN UNITS OF YEAR
90 POKE VM+VC,ASC(LEFT$(YR$,1))-48
100 POKE VM-1+VC,12
110 POKE VM-1+VC,44
120 POKE VM-1+VC,12 :REM STROBE IN TENS OF YEAR
130 PRINT:PRINT
140 PRINT " YEAR SET "
```

Table 8-8: Program to set the year

Make sure that the write-protect switch is OFF before the program is run. After the time is set, place the write-protect switch back in the write-protect mode.

#### 8.6.4. Clock Assembly Language Interface

The clock can be used in assembly language routines as with the other peripheral drivers. Two entry points are used to 'talk' with the RTC. The input entry point is used to return the time. The output entry point is used to set the time and set the format mode character. The entry points are:

|        |            |       |            |
|--------|------------|-------|------------|
| OUTPUT | Cx0B (hex) | INPUT | Cx08 (hex) |
|--------|------------|-------|------------|

The user should first set the time format mode by sending one of the mode characters defined above to the RTC. The mode character should be in the A register. A JSR instruction is then used to call the output routine.

When setting the time a continuous stream of characters as defined above should be sent to the output port. The string must end with a CR.

To return the time the user must call the input routine. The character in the A register is ignored. The time is returned in the format set previously starting at 200 (hex) in Apple memory. 200 is the beginning of the Apple input buffer and is used both in Basic and the Apple monitor. The string is terminated by a CR (0D hex). Upon return the X register will contain the number of characters in the string at 200 and the A register will contain 0D hex. An example routine follows that will read the time in AM/PM 12 hour format.

```
ORG $2000
LDA #$25          AN ASCII % AM/PM FORMAT
JSR $C70B        CALL OUTPUT RTC IN SLOT 7
JSR $C708        CALL INPUT TIME AT $200
```

Fig. 8-2: Clock Assembly Language Read Routine

When using assembly language calls to acquire the time from the clock it should be noted that the first character in the buffer is not time data. This character, a hex A0 or A2, is located at hex 200 in the buffer and shows up only with the AM/PM and 24 hour formats in both Integer and Applesoft basics. This character is used by the basics to avoid syntax errors when processing the string containing the time data. This character is not generated when using MOUNTAIN HARDWARE or Numeric formats and location 200 hex contains valid time data.

## 9. Use and Features of BSR/X-10 Interface

### 9.1. General Information

Before you test out and use the BSR interface on VERSAcards make sure that you have installed the ultrasonic transducer as outlined in the installation section of this manual. You should also familiarize yourself with the manual operation of the BSR/X-10 COMMAND CONSOLE. The VERSAcards-BSR interface will give the same results as the manual operation of the BSR/X-10 COMMAND CONSOLE.

The BSR COMMAND CONSOLE has 22 buttons that send commands to the various REMOTE MODULES that you have throughout your house. These buttons are labeled 1 through 16, ON, OFF, BRIGHT, DIM, ALL LIGHTS ON, and ALL LIGHTS OFF. The VERSAcards BSR interface can send all of these commands.

### 9.2. Sending Remote Commands

To send a command to the BSR CONSOLE a code must be transmitted to the COMMAND CONSOLE which the COMMAND CONSOLE will interpret as a button being pushed. The VERSAcards BSR interface must know which button you want to "push". You tell the VERSAcards interface which button you want to "push" by sending a character to the clock interface which corresponds to the BSR/X-10 COMMAND CONSOLE button. Table I below gives the COMMAND CONSOLE button the the corresponding character that needs to be sent to the VERSAcards-Clock interface.

| BUTTON | CHARACTER | BUTTON        | CHARACTER |
|--------|-----------|---------------|-----------|
| 1      | A         | 12            | L         |
| 2      | B         | 13            | M         |
| 3      | C         | 14            | N         |
| 4      | D         | 15            | O         |
| 5      | E         | 16            | P         |
| 6      | F         | ON            | Q         |
| 7      | G         | OFF           | R         |
| 8      | H         | BRIGHT        | S         |
| 9      | I         | DIM           | T         |
| 10     | J         | ALL LIGHTS ON | U         |
| 11     | K         | ALL OFF       | V         |

Table 9-1: BSR Button Codes

The following program gives an example of a BSR command being sent to the COMMAND CONSOLE with the VERSAcards Clock interface phantom for slot 4. Before you try the program, you should make sure that you have your BSR/X-10 COMMAND CONSOLE and any REMOTE MODULES set up correctly. First, make sure you have the ultrasonic model of the BSR/X-10 COMMAND CONSOLE. There is both an ultrasonic model and a non-ultrasonic model of the

COMMAND CONSOLE. Each REMOTE MODULE can be set to one of 16 stations. In addition each REMOTE MODULE has a house code indicated by a letter on the REMOTE MODULE. Make sure that the house code on the COMMAND CONSOLE and the house code on the REMOTE MODULE match. The program below assumes that the REMOTE MODULE is set to unit 5. Watch the red light on the front of your COMMAND CONSOLE when you send the BSR command. It should blink ON and OFF for a second or two. This indicates that a command is being received from the VERSAcad.

```
10 PR#4 :REM DOS IS NOT ACTIVE
20 PRINT "EQ" :REM USE CONTROL D FOR DOS PROGRAMS
30 PR#0
```

This program would turn REMOTE MODULE 5 ON. To turn REMOTE MODULE 5 OFF you would substitute LINE 20 above with: PRINT "ER"

### 9.3. Example of Use with BSR Remote Modules

Should you want to "play" with the BSR interface you should obtain at least 2 REMOTE MODULES and plug them in nearby. This will allow you to send commands to them and easily see the results. The following program is an easy way to send many commands without writing a special program for each one.

```
20 INPUT "COMMAND - ";A$ :REM DOS NOT ACTIVE
30 PR#n :REM USE CONTROL D FOR DOS ACTIVE PROGRAMS
40 PRINT A$;
50 PR#0
60 GOTO 20
```

Fig. 9-1: BSR Use Sample Program

In line 30 substitute n for the slot number that the Clock interface on VERSAcad is phantomd for.

### 9.4. Bright and Dim Controls

The BRIGHT and DIM controls on the BSR/X-10 COMMAND CONSOLE allow you to DIM (ie: make a light grow dimmer) or BRIGHTEN (ie: make a light grow brighter). On the BSR COMMAND CONSOLE you manually do this by holding down the the DIM or BRIGHT button. The longer you hold down the button (the 'duration' you hold the button) the more DIM or BRIGHT the device hooked up to the REMOTE MODULE would get. Only the LAMP and WALL SWITCH MODULES have DIM and BRIGHT ability. The APPLIANCE MODULE does not respond to these commands.

### 9.5. Duration Control

The LIGHT MODULES have 128 distinct steps between fully bright and totally dim. To simulate holding down a DIM or BRIGHT button on the COMMAND CONSOLE we have created the DURATION command. The duration command allows you to specify how DIM or how BRIGHT (within the 128 steps) you want the LIGHT MODULE to



get. The DURATION character is the "#". The amount of duration is specified by sending a character from A to Z immediately following the DURATION character. A duration of approximately 3.4 seconds will traverse the full DIM to BRIGHT or the BRIGHT to DIM range in one operation. Sending a "#A" specifies a DURATION of .1 seconds. Sending a "#Z" specifies a duration of 5.3 seconds. We only need a duration of 3.4 seconds to traverse the maximum range, so specifying a duration of greater than 3.4 seconds only insures that the entire range is traversed. Should you want to traverse only 40% of the range (3.4 seconds) then you would specify a DURATION of 40% times 5.3 seconds or 2.12 seconds. The closest DURATION character to 2.12 seconds would be the letter K. Sending a "#K" would specify a DURATION of 2.18 seconds. The following chart gives the DURATION values of each of the letters from A through Z.

| CHARACTER | DURATION | CHARACTER | DURATION | CHARACTER | DURATION |
|-----------|----------|-----------|----------|-----------|----------|
| A         | 0.10     | J         | 1.98     | S         | 3.85     |
| B         | 0.31     | K         | 2.18     | T         | 4.06     |
| C         | 0.52     | L         | 2.39     | U         | 4.26     |
| D         | 0.73     | M         | 2.60     | V         | 4.47     |
| E         | 0.94     | N         | 2.81     | W         | 4.68     |
| F         | 1.14     | O         | 3.02     | X         | 4.89     |
| G         | 1.35     | P         | 3.22     | Y         | 5.10     |
| H         | 1.56     | Q         | 3.43     | Z         | 5.30     |
| I         | 1.77     | R         | 3.65     |           |          |

**Table 9-2: BSR Duration Codes**

To try the DIM and BRIGHT commands you should connect a light to one of your REMOTE MODULES and try to DIM and BRIGHTEN your light. You can use the program of FIGURE 7 to do this.

NOTE: Duration commands affect only the next BSR command sent to VERSAcards. Subsequent commands return to a default duration of approximately 3/4 of a second. Therefore a duration code sequence should be sent prior to each DIM (T) or BRIGHT (S) commands.

## A. Assembly Language Interrupt Program

The following assembly language program can be used to display the time in the upper right-hand corner of the Apple video screen. This routine is located at \$300 hex.

To use this program type the hex object code listed in the program into the Apple memory. This is done using the Apple monitor. If you're not familiar with how to do this, consult your Apple Reference Manual. Once you are sure the program has been entered exactly as listed below, you can save the program on disk by using the Apple BSAVE command.

EXAMPLE (type) - BSAVE INT,A\$300,L\$93

Once saved the Basic program listed after the interrupt program below will load the interrupt module and begin the interrupt program. The time will be displayed in the upper right-hand corner of your apple monitor and be updated once every second. CAUTION! Read about interrupts and problems with DOS in the VERSAcad manual.

For this routine to work correctly the clock must not be disabled! It does not matter what slot the VERSAcad is in or what slot the Clock is phantomd for.

The assembly routines ENABLE and DISABLE can be called from Basic any time you want to enable or disable processor interrupts. Disabling processor interrupts will stop updating the time. Enabling processor interrupts will start updating the time again. Because of a bug in the Apple monitor and Apple DOS interrupts must be disabled before any DOS commands can be executed or you take the chance of damaging your floppy disk.

The assembly routine FIT finds the slot the PRINTER, VERSAcad, Clock is in. To find the printer slot call the routine at entry point VPRT. To find the VERSAcad slot call the routine at entry point VERS. To find the Clock slot call the entry point at VCLK. Upon return from these routines the slot can be read from BASIC by executing the following Basic statement:

```
SLOT=PEEK(881)-192
```

The actual interrupt routine starts at 300 hex.

```
*****
*
*   THIS PROGRAM IS CONTAINED ON THE APPLICATIONS DISK AVAILABLE *
* FROM PROMETHEUS. *
*
*****
```

|             |         |              |                                 |
|-------------|---------|--------------|---------------------------------|
| 0300-8A     | INTS    | ORG \$300    | SAVE X AND Y REGISTERS          |
| 0301-48     |         | TXA          |                                 |
| 0302-98     |         | PHA          |                                 |
| 0303-48     |         | TYA          |                                 |
| 0304-A901   |         | PHA          |                                 |
| 0306-8522   |         | LDA #01      | PROTECT TOP LINE OF APPLE       |
| 0308-205C03 |         | STA \$22     | VIDEO MONITOR                   |
| 0308-8D2E03 |         | JSR VCLK     | FIND CLOCK SLOT CN RETURNED     |
| 030E-8D2B03 |         | STA CLKS+2   | MODIFY THESE LOCATIONS TO       |
| 0311-206303 |         | STA CLKX+2   | POINT AT CLOCK SLOT             |
| 0314-0A     |         | JSR VERS     | FIND VERSACARD SLOT (SERIAL)    |
| 0315-0A     |         | ASL A        | SHIFT TO GET NO WHERE           |
| 0316-0A     |         | ASL A        | N=SLOT VERSACARD IS PHYSICALLY  |
| 0317-0A     |         | ASL A        | LOCATED IN                      |
| 0318-A8     |         | TAY          | PUT IN Y REGISTER               |
| 0319-A91F   |         | LDA #01F     | RESET INT REGISTER ON VERSACARD |
| 0318-9982C0 |         | STA \$C082,Y | INT REGISTER AT \$C082 +NO      |
| 031E-A220   |         | LDX #20      | SAVE 32 BYTES OF BASIC          |
| 0320-BD0002 | BUFS    | LDA \$200,X  | BUFFER TO PRESERVE ITEMS        |
| 0323-48     |         | PHA          | IN PROGRESS - BYTES SAVED       |
| 0324-CA     |         | DEX          | ON STACK                        |
| 0325-10F9   |         | BPL BUFS     | BRANCH IF NOT SAVED 32          |
| 0327-A920   | MODE    | LDA #20      | SELECT MOUNTAIN FORMAT          |
| 0329-200BC7 | CLKX    | JSR \$C70B   | SET CLOCK MODE                  |
| 032C-2008C7 | CLKS    | JSR \$C708   | READ TIME                       |
| 032F-A20D   |         | LDX #0D      | SAVE TIME STRING NOW IN BUFFER  |
| 0331-BD0002 | CLK     | LDA \$200,X  | IN RIGHT HAND CORNER OF         |
| 0334-9D1A04 | SCRN    | STA \$41A,X  | APPLE VIDEO                     |
| 0337-CA     |         | DEX          |                                 |
| 0338-10F7   |         | BPL CLK      | FALL THROUGH WHEN DONE          |
| 033A-A200   |         | LDX #00      | RESTORE 32 BYTES SAVED ON STACK |
| 033C-68     | OPP     | PLA          | BACK IN BASIC BUFFER            |
| 033D-9D0002 |         | STA \$200,X  |                                 |
| 0340-E8     |         | INX          |                                 |
| 0341-E021   |         | CPX #21      | SEE IF 32 BYTES YET             |
| 0343-DOF7   |         | BNE OPP      |                                 |
| 0345-A95F   |         | LDA #5F      | RESET INTERRUPT REGISTER        |
| 0347-9982C0 |         | STA \$C082,Y | TO ON                           |
| 034A-68     |         | PLA          | RESTORE X AND Y BACK            |
| 034B-A8     |         | TAY          |                                 |
| 034C-68     |         | PLA          |                                 |
| 034D-AA     |         | TAX          |                                 |
| 034E-A545   |         | LDA \$45     | GET A REGISTER                  |
| 0350-40     |         | RTI          | RETURN FROM INTERRUPT           |
| 0351-58     | ENABLE  | CLI          | ENABLE PROCESSOR INTERRUPTS     |
| 0352-60     |         | RTS          | RETURN                          |
| 0353-78     | DISABLE | SEI          | DISABLE PROCESSOR INTERRUPTS    |
| 0354-60     |         | RTS          | RETURN                          |
| 0355-A989   | VPRT    | LDA #89      | POINT SIG AT PRINTER SIG BYTES  |
| 0357-8D7303 |         | STA MSIG+1   | CHANGE 0373 TO CN               |
| 035A-D00C   |         | BNE FIT      |                                 |
| 035C-A983   | VCLK    | LDA #83      | POINT SIG AT CLOCK SIG BYTES    |
| 035E-8D7303 |         | STA MSIG+1   |                                 |
| 0361-D005   |         | BNE FIT      |                                 |

|             |       |                    |                               |
|-------------|-------|--------------------|-------------------------------|
| 0363-A986   | VERS  | LDA #86            | POINT SIG AT VERSA SIG BYT    |
| 0365-8D7303 |       | STA MSIG+1         |                               |
| 0368-A9C7   | FIT   | LDA #C7            | START AT SLOT 7 AND WORK TO   |
| 036A-8D7103 |       | STA NXTSL+2        | SLOT 0                        |
| 036D-A002   |       | LDY #02            | CHECK FOR 3 SIGNATURE BYTES   |
| 036F-B90BC7 | NXTSL | LDA \$C70B,Y       | READ SIGNATURE BYTE FROM SLOT |
| 0372-D98303 | MSIG  | CMP SIG,Y          | COMPARE WITH SIGNATURE BYTE   |
| 0375-F015   |       | BEQ FND            | IF COMPARE GO TO FND          |
| 0377-CE7103 |       | DEC NXTSL+2        | CN-1                          |
| 037A-AD7103 |       | LDA NXTSL+2        | SEE IF AT CO IF SO RETURN TO  |
| 037D-C9C0   |       | CMP #CO            | CALLER                        |
| 037F-F011   |       | BEQ DONE           |                               |
| 0381-DOEC   |       | BNE NXTSL          | GO CHECK NEXT SLOT            |
| 0383-18B808 | SIG   | DFB \$18,\$B8,\$08 | CLOCK SIGNATURE BYTES         |
| 0386-008D78 |       | DFB \$00,\$8D,\$78 | VERSACARD SIGNATURE BYTES     |
| 0389-1248A5 |       | DFB \$12,\$48,\$A5 | PRINTER SIGNATURE BYTES       |
| 038C-88     | FND   | DEY                | SEE IF ALL 3 BYTES MATCH      |
| 038D-10EO   |       | BPL NXTSL          | BRANCH IF NOT ALL 3 MATCH YET |
| 038F-AD7103 | MATCH | LDA NXTSL+2        | GET CN N=SLOT # MUST HAVE     |
| 0392-60     | DONE  | RTS                | MATCHED IF WE GOT HERE        |

Make sure you have typed in the object code correctly. If you need help on how to do this consult your Apple Reference Manual about the Apple monitor.

Once you have saved the binary file as INT use the following BASIC program to load INT and start the interrupt routine. To stop interrupts you must disable interrupts or hit the RESET key on your Apple. This is done by a CALL 851.

```

10 HOME
20 PRINT:PRINT
30 PRINT "   LOADING INTERRUPT MODULE "
40 D$=CHR$(4) : REM THIS IS NECESSARY FOR APPLE DOS
50 PRINT D$;"BLOAD INT"
60 CALL 867 :REM FIND THE SLOT VERSACARD IS IN
65 REM MUST NOW POKE C082+NO WITH 5F HEX N=SLOT VERSACARD IS IN
70 POKE 49282+(PEEK(881)-192)*16,95 :REM SETS INTERRUPTS ON ON VERSACARD
80 POKE 1022,00 : REM SET INTERRUPT VECTOR AT 3FE - 3FF TO 300 HEX
90 POKE 1023,3
100 CALL 849 : REM ENABLE PROCESSOR INTERRUPTS
110 REM TIME SHOULD START DISPLAYING IN TOP RIGHT HAND CORNER

```

NOTE: The REM statement is merely a remarks statement in the program and it does not effect the running of the program. It is purely for commentary purposes. You can name the program for your clock control anything you like except "INT".  
To save (type) - SAVE START INT  
To run (type) - RUN START INT

This will save the above BASIC program to disk. When you RUN this program, it will automatically load the assembly language file that you BSAVED previously and the time should show up in the top right hand corner of the screen.

## B. HARDWARE REGISTERS AND MEMORY MAP INFORMATION

The I/O ports on VERSAcards are located as follows:

| ADDRESS                     | FUNCTION   |
|-----------------------------|--|
| \$C0x2                      | Clock/BSR/INT control, write only register   |
| \$C0x3                      | Clock data, printer busy, interrupt enable status - read operation<br>Clock data - write operation |
| \$C0x4,C0x6,<br>\$C0xC,C0xE | Serial status - read operation<br>Serial control - write operation                                 |
| \$C0x5,C0x7,<br>\$C0xD,C0xF | Serial data (receive) - read operation<br>Serial data (transmit) - write operation                 |
| \$C0y0 thru<br>\$C0yF       | Parallel data - write-only register  |

where  $x = 8 + \text{slot \# VERSAcards is installed into,}$   
and  $y = 8 + \text{slot \# printer is addressed for.}$

For the meaning of the 6850 registers, consult a data sheet available from several manufacturers. The bit locations of the clock registers are given in the table that follows. For the meaning and proper timing of these signals, a data sheet on this part should also be obtained.

| REGISTER           | BIT 0 | 1  | 2  | 3  | 4    | 5   | 6   | 7   |
|--------------------|-------|----|----|----|------|-----|-----|-----|
| BSR/Clock control  | A0    | A1 | A2 | A3 | RD   | WR  | INT | BSR |
| Clock Data - write | D0    | D1 | D2 | D3 | x    | x   | x   | x   |
| Clock Data - read  | D0    | D1 | D2 | D3 | Busy | INT | x   | x   |

Bit 6 of the BSR/Clock control register is the interrupt control bit as explained in Section 7.7.3. Bit 5 of the Clock Data read register is the status of interrupt enable for VERSAcards - A 1 means that interrupts are enabled, and a 0 means they are disabled. VERSAcards powers up with interrupts disabled for the card.

### C. IMPORTANT FIRMWARE LOCATIONS

The following table describes important and useful bytes in the VERSAcad firmware. The byte locations are especially useful should you want to change the default characteristics of the VERSAcad firmware.

To be able to change the default locations you will need a 2716 EPROM eraser and programmer so that you can modify the bytes necessary. All values are in hex. Prometheus will modify an EPROM for you should for a cost of \$25.00.

| LOCATION | DESCRIPTION   | DEFAULT VALUE |
|----------|---|---------------|
| C8B9     | 6850 INITIALIZATION BYTE FOR SERIAL   | \$11          |
| CFAE     | 6850 INITIALIZATION BYTE - TERMINAL MODE  | \$11          |
| C8C1     | INITIALIZATION BYTE FOR 'BITS' - SERIAL   | \$30          |
| C940     | INITIALIZATION BYTE FOR 'BITS' - PARALLEL   | \$32          |
| CF68     | LOWER TO UPPER CASE CONVERSION BYTE FOR<br>TERMINAL MODE<br>SHOULD NO CONVERSION BE DESIRED MODIFY TO | \$DF<br>\$FF  |
| C8A9     | DEFAULT VALUE FOR DELAY AFTER CARRAIGE RETURN   | \$03          |
| CEFE     | DEFAULT VALUE FOR PAGE LINES  | \$41          |

In the VERSAcad firmware a number of flags are used to determine if certain firmware options are ON or OFF. This location is called BITS and the initialization for parallel and serial is shown above. Each bit has a different meaning in BITS as described below.

**BITS:**

| BIT | DESCRIPTION                                 |
|-----|---|
| 0   | PAGING ON OR OFF                            |
| 1   | RESERVED                                    |
| 2   | GRAPHICS MODE ON OR OFF                     |
| 3   | RESERVED                                    |
| 4   | VIDEO ECHO ON OR OFF (40 COLUMNS)           |
| 5   | LINE FEED AFTER CR ON OR OFF                |
| 6   | RESERVED                                    |
| 7   | HIGH (8th) BIT SET OR CLEAR 1=SET 0=NOT SET |

A bit set to 1 in that location indicates that the option is ON

## D. 6850 UART HARDWARE REGISTER SUMMARY

The firmware in the Versacard is programmed to use the most common protocol. (1 start bit, 8 data bits, 2 stop bits, no parity). However, we recognize that there are many users who need to follow other protocols.

The following is a summary of the 6850 UART chip operation. For a complete operations guide contact your local Motorola office and ask for a 6850 data sheet.

Versacard I/O locations:

The Versacard serial status port is located at  $C084+N0$ , where N is equal to the slot number where the Versacard is physically located. This is the address for both the status and control registers.

The Versacard data register is at  $C085+N0$  where N is equal to the slot number where the Versacard is physically located. The transmit data register and receive data registers are located at this address.

The following are a few code examples:

A) Initialize the 6850:

|              |                                 |
|--------------|---------------------------------|
| LDY \$778    | Normally holds \$N0             |
| LDA #\$03    | Reset code for the 6850         |
| STA \$C084,Y | Do master reset                 |
| LDA #\$11    | Set for 8 data bits, no parity, |
| STA \$C084,Y | 2 Stop bits, Divide by 16       |

B) Receive a character:

If the "Receive Data Register Full (Bit 0)" bit is high, then a character is in the Receive Data Register. Once you read the character, the 6850 will automatically set this bit to a 0 until another character is received.

|       |              |                            |
|-------|--------------|----------------------------|
|       | LDY \$778    | Get \$N0                   |
| LOOP  | LDA \$C084,Y | Get status byte            |
|       | ROL          | Shift Bit 0 to carry       |
|       | BCS CHRIN    | If C=1 the character ready |
|       | BCC LOOP     | Loop until character       |
| CHRIN | LDA \$C085,Y | Get the character          |

C) Send a character:

If the "Transmit Data Buffer Empty (Bit 1)" bit is high, then it is OK to send a character out. Remember that if Pin 5 on the Versacard is low then the Transmit Data Buffer Bit will always be a 0. This is part of the hardware handshaking of the 6850. If the character is being shifted out then Bit 1 will be a 1 indicating the buffer is full.

```

LDY $778           Get $NO
LOOP LDA $C084,Y   Get status byte
ROL               Put Bit 1 into carry flag
ROL
BCS CHROUT
BCC LOOP          Loop until character ready
CHROUT
(Get character)

STA $C085,Y       Send character to data port

```

6850 Initialization Byte on Versacard:

The bytes on Versacard Version 1.51 firmware that initialize the 6850 are located at \$C8B9 and \$CFAE(Hex). These bytes are normally \$11 (Hex). You can change these bytes to whatever you would like the 6850 initialized to. Remember that the 6850 is initialized everytime a PR#n or IN#n (n = slot number of Versacard serial port) is done.

From the 6850 Data Sheet:

C085 + NO = READ and WRITE DATA REGISTER

C084 + NO = STATUS REGISTER (READ) and CONTROL REGISTER (write)

The following are bit description of the status register:

- |   |                                  |
|---|----------------------------------|
| READ Bit 0 = Receive Data Register Full | 1 = Transmit Data Register Empty |
| 2 = DCD                                 | 3 = CTS                          |
| 4 = Framing Error                       | 5 = Receiver Overrun             |
| 6 = Parity Error                        | 6 = Interrupt Request            |



## Changing Initialization byte:

To construct the proper initialization byte, select one value from each section below and add their hexadecimal values. Edit locations \$CBB9 and \$CFAE of the code on the 2716 EPROM and burn a new EPROM. (The EPROM's effective addresses are from \$C800 to \$CFFF.) If you do not have the facility to program your own EPROMS, Prometheus will do it for you for a nominal charge of \$25.

| Function  | VALUE | EXAMPLE |
|---|-------|---------|
| Divide clock by 1                               | \$00  |         |
| Divide clock by 16                              | \$01  | \$01    |
| Divide clock by 64                              | \$02  |         |
| -----   |       |         |
| Function  |       |         |
| 7 Bits + Even Parity + 2 Stop                   | \$00  |         |
| 7 Bits + Odd Parity + 2 Stop bits               | \$04  |         |
| 7 Bits + Even Parity + 1 Stop bit               | \$08  |         |
| 7 Bits + Odd Parity + 1 Stop bit                | \$0C  |         |
| 8 Bits + 2 Stop bits                            | \$10  | \$10    |
| 8 Bits + 1 Stop bit                             | \$14  |         |
| 8 Bits + Even Parity + 1 Stop bit               | \$18  |         |
| 8 Bits + Odd Parity + 2 Stop bits               | \$1C  |         |
| -----   |       |         |
| Function  |       |         |
| RTS = Low, Transmitting Interrupt Disabled      | \$00  | \$00    |
| RTS = Low, Transmitting Interrupt Enabled       | \$20  |         |
| RTS = High, Transmitting Interrupt Disabled     | \$40  |         |
| RTS = Low, Transmitting Interrupt Disabled      | \$60  |         |
| Transmits a break level on Transmit Data output |       |         |
| -----   |       |         |
| Disable Receive Interrupt                       | \$00  | \$00    |
| Enable Receive Interrupt                        | \$80  |         |
| -----   |       |         |
| T O T A L                                       |       | \$11    |

RECEIVE INTERRUPT ENABLE BIT (C7) - When a high level is in Bit position 7 of the Control register the following Interrupts will be enabled:

- \* Receive Data Register Full
- \* Overrun
- \* A Low to High transission on the DCD signal line

## E. CLOCK DATA REGISTERS

| ADDRESS |    |    |    | / | FUNCTION  | DATA I/O |    |    |    | / | RANGE   | / | NOTES    |
|---------|----|----|----|---|-----------|----------|----|----|----|---|---------|---|----------|
| A3      | A2 | A1 | A0 |   |           | /        | D3 | D2 | D1 |   |         |   |          |
| 0       | 0  | 0  | 0  | / | seconds1  | *        | *  | *  | *  | / | 0-9     | / | note 1   |
| 0       | 0  | 0  | 1  | / | seconds10 | *        | *  | *  | *  | / | 0-5     | / | note 1   |
| 0       | 0  | 1  | 0  | / | minutes1  | *        | *  | *  | *  | / | 0-9     | / |          |
| 0       | 0  | 1  | 1  | / | minutes10 | *        | *  | *  | *  | / | 0-5     | / |          |
| 0       | 1  | 0  | 0  | / | hours1    | *        | *  | *  | *  | / | 0-9     | / |          |
| 0       | 1  | 0  | 1  | / | hours10   | +        | +  | *  | *  | / | 0-1/0-2 | / | note 2   |
| 0       | 1  | 1  | 0  | / | weekday   | *        | *  | *  | *  | / | 0-6     | / | 0=SUNDAY |
| 0       | 1  | 1  | 1  | / | date1     | *        | *  | *  | *  | / | 0-9     | / |          |
| 1       | 0  | 0  | 0  | / | date10    | +        | *  | *  | *  | / | 0-3     | / | note 3   |
| 1       | 0  | 0  | 1  | / | month1    | *        | *  | *  | *  | / | 0-9     | / |          |
| 1       | 0  | 1  | 0  | / | month10   |          |    |    | *  | / | 0-1     | / |          |
| 1       | 0  | 1  | 1  | / | year1     | *        | *  | *  | *  | / | 0-9     | / |          |
| 1       | 1  | 0  | 0  | / | year10    | *        | *  | *  | *  | / | 0-9     | / |          |
| 1       | 1  | 1  | 1  | / | interrupt | d        | c  | b  | a  | / |         | / | note 4   |

### NOTES:

**General:** Valid data bits are shown as a "\*". Special data bits are shown as a "+", see notes below.

**Note 1:** When the seconds counters are written, they are reset to 00, regardless of data present.

**Note 2:** Data bit D2 is the AM/PM bit (1=PM) and data bit D3 is the 24 hour format bit (1=24 hour format).

**Note 3:** Data bit D2 is the leap year bit, where 1 equals 29 days in month 2 (28 days otherwise). Clock will reset this bit automatically on March 1st.

**Note 4:** Interrupt frequencies will appear on the data lines when this address is present and the read line is activated (=1). Data bit D0 can be polled by assembly language for higher resolution timing. Rates follow next page.

a = 1024 hertz, square wave  
b = 1 pulse per second, negative for 120 uS.  
c = 1 pulse per minute, " " " "  
d = 1 pulse per hour, positive " " "

#### READING THE CLOCK:

The clock is read by writing to the clock control port the proper address (lower 4 bits) with the read line active (bit 4 = 1). The data is then read from the data port, using the lower four bits for bad data. Data is constantly changing, so care must be taken to insure correct time data.

#### SETTING THE CLOCK:

Time is written to the clock in a similar fashion. Data is written first to the data port for the internal counter of interest. The address of that counter is then written to the clock control port, followed by that same address with the write line active (bit 5 = 1) and finally the address written again with the write line inactive (=0). This is done to strobe the data into the clock chip and meet timing requirements.

## F. TROUBLESHOOTING

The most common problem that could occur with VERSAcad is memory conflicts due to improper settings on the slot select switches (S1). For example, if the printer is set for slot 6 there would be a conflict with the system's disk controller, if present. This problem would most likely show up as an inability of the Apple to locate the controller when booting Apple Dos or Apple Pascal. Using CP/M with the Softcard, similar problems can exist.

Also, setting switch 1 in Switch Bank 2 to OFF will cause the printer to miss data sent to it. See Section 6.2.

Problems with the Serial Port usually can be traced to a error in connecting the device to the appropriate communication lines. If the lines are correct, then regardless of the baud rate setting usually some characters will appear on the screen. Although no sense can be made from the display, this means at least some data is getting through. If the display looks okay during short responses but drops characters during long printouts then the problem is in the handshake lines (busy/ready lines) and not in the data lines.

A quick check of the serial port and the cable can be made with the use of a loop-back connector. This is a RS-232C type "D" connector wired as follows:

```
Pin 2 <-----> Pin 3
Pin 4 <-----> Pin 5
Pin 6 <-----> Pin 20
```

Plug this special connector into the end of the cable that goes to VERSAcad, and send data out the serial and then attempt to read it back. The data you receive should be the same data that you sent. Sending data out the serial port without the connector attached should 'hang' the system until this connector is attached.

Similar problems can occur with the Printer Port. If strange characters or graphics appear on the printer then this is usually due to the eighth bit being set when it shouldn't be. If nothing shows up and the Apple no longer responds (hangs), then this is an indication that the printer is not accepting the data sent to it. Placing the printer off line produces similar results. The printer can be checked for busy status by polling the busy line port on VERSAcad. See Appendix B for the I/O Port location.

Problems with the clock usually can be traced to the program accessing it. For absolute accuracy in reading the clock, read the time two or more times and compare the readings obtained. If these readings differ more than a second or two and the problem cannot be traced to the program, then there may be a problem in the clock circuitry itself. Since there are no user settings in this area, the card should be returned for repair.

## G. SPECIFIC SERIAL DEVICES CABLING REQUIREMENTS

If the device you are attempting to attach to VERSAcad's serial port is not listed below, then consult SECTION 5.2 for information regarding VERSAcad's reaction to the presence or absence of various RS-232C signals.

### EXTERNAL TERMINAL:

VERSAcad will hook directly to an external terminal with a reversing type of cable or reversing adapter (null modem). This is usually a male to male cable that attaches to the female standard RS-232C cable that Prometheus normally ships. Some terminals (such as the Heathkit/Zenith H-19) require one female end since the connector on the back is male. The pinout of the cable is as follows:

| MALE END | CABLE   | MALE (or FEMALE) END |
|----------|---------|----------------------|
| PIN 2    | <-----> | PIN 3                |
| PIN 3    | <-----> | PIN 2                |
| PIN 4    | <-----> | PIN 5                |
| PIN 5    | <-----> | PIN 4                |
| PIN 7    | <-----> | PIN 7                |

Most terminals will work with this cable. If the terminal or VERSAcad does not respond with this configuration then the secondary handshake lines such as DTR (pin 20) or DSR (pin 6) should be checked. If upon examination of the interface a line is found to be floating LOW and the terminal needs it high to operate, then tie that line to pin 20 (DTR) which is always at a high level when VERSAcad is in the Apple and power is on.

### MODEMS:

VERSAcad will interface DIRECTLY with most modems by using a straight through cable with a male "D" DB25 RS-232 connector on the modem end. If you have a modem with a male connector at the modem and you have a standard Prometheus male modem cable, then you will need to make a cable to convert from a male to a female connector.

## SERIAL PRINTERS

The most difficulty usually encountered in interfacing serial devices is with printers since most of them use different handshaking lines to control the data flow. If PIN 5 is not connected properly and the baud rate exceeds the printer's print rate, then parts of the data to be printed will be lost. This can always be solved by running at a slower transmission rate than the print rate, but this often results in a slower than optimum print rate. The following figures show the connections to some of the more popular printers available.

### NEC SPINWRITER

| VERSAcad      | SPINWRITER |
|---------------|------------|
| PIN 2 <-----> | PIN 3      |
| PIN 5 <-----> | PIN 19     |
| PIN 7 <-----> | PIN 7      |
|               | -> PIN 5   |
|               | -> PIN 6   |
|               | -> PIN 20  |
|               | -> Pin 8   |

THESE PINS ARE  
CONNECTED  
TOGETHER

### QUME

| VERSAcad      | QUME   |
|---------------|--------|
| PIN 2 <-----> | PIN 3  |
| PIN 5 <-----> | PIN 20 |
| PIN 7 <-----> | PIN 7  |

### IDS

| VERSAcad      | IDS 125 |
|---------------|---------|
| PIN 2 <-----> | PIN 3   |
| PIN 5 <-----> | PIN 5   |
| PIN 7 <-----> | PIN 7   |

FOR PARALLEL VERSION OF IDS PRINTERS SEE Figure 2-2

### ANADEX

Same as QUME above

### HEATHKIT H-14

| VERSAcad      | HEATH  |
|---------------|--------|
| PIN 2 <-----> | PIN 3  |
| PIN 5 <-----> | PIN 15 |
| PIN 7 <-----> | PIN 7  |

## DIABLO 630

### VERSAcard

### DIABLO

```
PIN 2 <-----> PIN 3
PIN 5 <-----> PIN 11
PIN 7 <-----> PIN 7
                |-> PIN 6   TIE PINS 6 AND 20
                |-> PIN 20  TOGETHER
```

DAISYWRITER IS THE SAME AS THE DIABLO 630 ABOVE - THIS PRINTER USED AN EDGE CONNECTER INSTEAD OF A DB-25 TYPE OF CONNECTOR SO MAKE SURE THAT YOU HAVE THE PIN NUMBER CORRECT

C-IOTH 8510 (SERIAL) or NEC 8023 (SERIAL) is the same as QUME shown above.

### MICROLINE PRINTERS

### SWITCH SETTING

```
PIN 2 -----> PIN 3   SWITCH 1 - NOT USED
PIN 7 <-----> PIN 7   SWITCH 2 - ON
PIN 5 <-----> PIN 11  SWITCH 3 - OFF
                PIN 6   SWITCH 4-8 ON
                PIN 20  SWITCH 9-10 OFF
                SWITCH 11 ON
                SWITCH 12-14 OFF
```

### TRENCOM

```
PIN 2 -----> PIN 3   SWITCH SETTINGS
PIN 7 <-----> PIN 7
PIN 5 <-----> PIN 6   SWITCH 1 - ON
                PIN 20  SWITCH 2-8 OFF
                PIN 4
                PIN 5
```

### TELETYPE MODEL 43

```
PIN 2 -----> PIN 3
PIN 7 <-----> PIN 7
                PIN 5,6,8,20 TIED TOGETHER
```

### C-ITOH F-10

```
PIN 2 -----> PIN 3
PIN 7 <-----> PIN 7
PIN 5 <-----> PIN 20
                PIN 5,6 TIED TOGETHER
```

## H. PROGRAM TO READ THE CLOCK/CALENDAR in CP/M

```
1 REM: THIS IS A PROGRAM THAT READS THE CLOCK IN MBASIC UNDER CP/M.
2 REM: IT WILL AUTOMATICALLY FIND THE CLOCK AND OUTPUT THE TIME.
3 REM: IF A CLOCK IS NOT FOUND IT WILL OUTPUT "NO CLOCK FOUND"
4 X=0
5 FOR Z = 7 TO 1 STEP -1
8 Q = &HE00B + (256 * Z)
12 IF PEEK (Q) = 24 AND PEEK (Q+1) = 184 AND PEEK (Q+2) = 8 THEN X = &HC0 + Z: Z = 1
15 NEXT Z: IF X = 0 THEN PRINT " NO CLOCK FOUND": END
40 DIM T(35)
50 T$ = " ": TY$ = " "
60 A$ = CHR$(&H2A) + CHR$(&HDE) + CHR$(&HF3) + CHR$(&H77) + CHR$(&HC9)
80 B = VARPTR(A$)
90 B = PEEK(B+1) + (PEEK(B+2) * 256)
100 B = B + 65536 * (B > 32767)
110 HOME
130 FOR I = &HF200 TO &HF220
140 T(I - &HF200 + 1) = PEEK(I)
150 NEXT I
160 POKE &HF039, X
180 POKE &HF045, ASC("Z")
200 POKE &HF3D0, &HB: POKE &HF3D1, X
210 CALL B
230 POKE &HF3D0, &HO: POKE &HF3D1, X
240 CALL B
260 FOR I = &HF201 TO &HF216
270 TX = PEEK(I)
280 IF TX >= 128 THEN TX = TX - 128
290 T$ = T$ + CHR$(TX)
300 NEXT I
310 PRINT: PRINT "THE TIME IS -";: INVERSE: PRINT " ";
320 PRINT T$:;: PRINT " ": NORMAL
340 POKE &HF045, ASC("/")
360 POKE &HF3D0, &HB: POKE &HF3D1, X
380 CALL B
400 POKE &HF3D0, &HO: POKE &HF3D1, X
420 CALL B
440 FOR I = &HF200 TO &HF203
450 TZ = PEEK(I)
460 IF TZ >= 128 THEN TZ = TZ - 128
470 TY$ = TY$ + CHR$(TZ)
480 NEXT I
490 PRINT: PRINT "THE YEAR IS -";: INVERSE: PRINT " ";
500 PRINT TY$:;: PRINT " ": NORMAL
520 FOR I = &HF200 TO &HF220
530 POKE I, T(I - &HF200 + 1)
540 NEXT I
550 END
```



### SWITCH SETTINGS SWITCH BANK I

The VERSAcad has three major functions on one card; serial, parallel, and clock. To make addressing of these functions Apple compatible, the VERSAcad is setup as follows:

The serial interface slot number is determined by the physical location of the VERSAcad. The clock and parallel portions are addressed to other slots using the following configuration.

| PRINTER<br>PHANTOMED<br>IN<br>SLOT # | SLOT NUMBER FOR<br>PRINTER IN BINARY: |      |      | SLOT NUMBER FOR<br>CLOCK/BSR IN BINARY: |      |      |
|--------------------------------------|---------------------------------------|------|------|---|------|------|
|                                      | sw 1                                  | sw 2 | sw 3 | sw 4                                    | sw 5 | sw 6 |
| 1                                    | off                                   | on   | on   | off                                     | on   | on   |
| 2                                    | on                                    | off  | on   | on                                      | off  | on   |
| 3                                    | off                                   | off  | on   | off                                     | off  | on   |
| 4                                    | on                                    | on   | off  | on                                      | on   | off  |
| 5                                    | off                                   | on   | off  | off                                     | on   | off  |
| 6                                    | on                                    | off  | off  | on                                      | off  | off  |
| 7                                    | off                                   | off  | off  | off                                     | off  | off  |

Example: If printer is phantomed for slot 4, switches 1,2, and 3, will be set at: on, on, and off.

### SWITCH SETTINGS SWITCH BANK II

#### BAUD RATE SWITCHES:

The transmission data rate (baud rate) is determined by the setting of switch bank S2 switches 2 through 5 where a switch in the ON position represents a 0. Switch 5 is the least significant bit (LSB). Baud rates are set according to the Table below.

| <u>Baud Rate</u> | <u>Switch</u> |     |     |     | <u>Baud Rate</u> | <u>Switch</u> |     |     |     |
|------------------|---------------|-----|-----|-----|------------------|---------------|-----|-----|-----|
|                  | 2             | 3   | 4   | 5   |                  | 2             | 3   | 4   | 5   |
| 50               | on            | on  | on  | on  | 1600             | off           | on  | on  | on  |
| 75               | on            | on  | on  | off | 2000             | off           | on  | on  | off |
| 110              | on            | on  | off | on  | 2400             | off           | on  | off | on  |
| 134.5            | on            | on  | off | off | 3600             | off           | on  | off | off |
| 150              | on            | off | on  | on  | 4800             | off           | off | on  | on  |
| 300              | on            | off | on  | off | 7200             | off           | off | on  | off |
| 600              | on            | off | off | on  | 9600             | off           | off | off | on  |
| 1200             | on            | off | off | off | 19200            | off           | off | off | off |

Switch 1 - When not using printer interface switch 1 is in the off position.

#### CLOCK WRITE-PROTECT SWITCH

Switch 6 of Switch Bank 2 is the write enable switch for the Clock. Setting this switch to ON write enables the Clock; Setting this switch to OFF write protects the Clock. The user should always write protect the Clock after he has set the time to provide maximum protection against accidental writes to the Clock.

**NOTE! BE CERTAIN THAT SWITCHES ARE IN THE "ON" OR "OFF" POSITION AS DESIGNATED ON THE SWITCH PACKAGE!!**

## VERSACARD PARTS LISTING

This list will include part location on card and part number.  
Refer to Diagram.

### IC's

|           |                 |             |
|-----------|-----------------|-------------|
| U1-74LS85 | U10-74LS02      | U19-1488    |
| U2-74LS85 | U11-74LS00      | U20-74LS173 |
| U3-74LS00 | U12-74LS09      | U21-74LS367 |
| U4-74LS85 | U13-N8T245      | U22-74LS273 |
| U5-74LS85 | U14-MM2716Q-1   | U23-74LS374 |
| U6-74LS08 | U15-74LS155     | U24-MSM5832 |
| U7-74LS05 | U16-SMC8126-005 | U25-74LS74  |
| U8-74LS11 | U17-MC6850      | U26-74LS74  |
| U9-74LS30 | U18-1489        | U27-74LS74  |

### RESISTORS

All resistors are 1/4 watt  
5% carbon film type

|            |          |          |
|------------|----------|----------|
| R1-5.6K    | R6-47K   | R11-2.2K |
| R2-5.6K    | R7-5.6K  |          |
| R3-220 ohm | R8-5.6K  |          |
| R4-2.2K    | R9-5.6K  |          |
| R5-5.6K    | R10-5.6K |          |

### CAPACITORS

C1 through C6 - .1mf 50v. MONOLITHIC  
C7 - 20pf. 500v. SILVER MICA  
C8 - C220C1042 .1mf 50v. MONOLITHIC  
C9 - C220C1042 .1mf 50v. MONOLITHIC  
C10 - 1000pf 50v. AXIAL  
VC1 - 3-20pf variable trimmer

### TRANSISTORS

Q1-2N4403 Q2-2N3904 Q3-2N3904

### CRYSTALS

Y1-4.9152 MHZ CRYSTAL  
Y2-32.768 KHZ WATCH CRYSTAL

### DIODES

D1 AND D2 - IN270, IN4149 OR EQUIVALENT

### SIP PULL UP PACKAGE

RP1-CTS750.101.R5.6K  
RP2-CTS750.61.R2.2K  
RP3-CTS750.61.R10K

### HEADERS

J1-1x2 WIRE WRAP HEADERS  
J2-2x13 WIRE WRAP HEADERS  
J3-2x10 WIRE WRAP HEADERS  
J4-1x2 WIRE WRAP HEADER  
HEADER JUMPER-1500 IMM  
JH1-2x3 WIRE WRAP HEADERS  
JH2-NOT IN USE  
JH3-NOT IN USE  
JH4-1x2 WIRE WRAP HEADERS  
JH5-1x2 WIRE WRAP HEADERS

### SWITCHES

S1-CTS206-6  
S2-CTS206-6

## I. PARTS LIST AND DIAGRAM

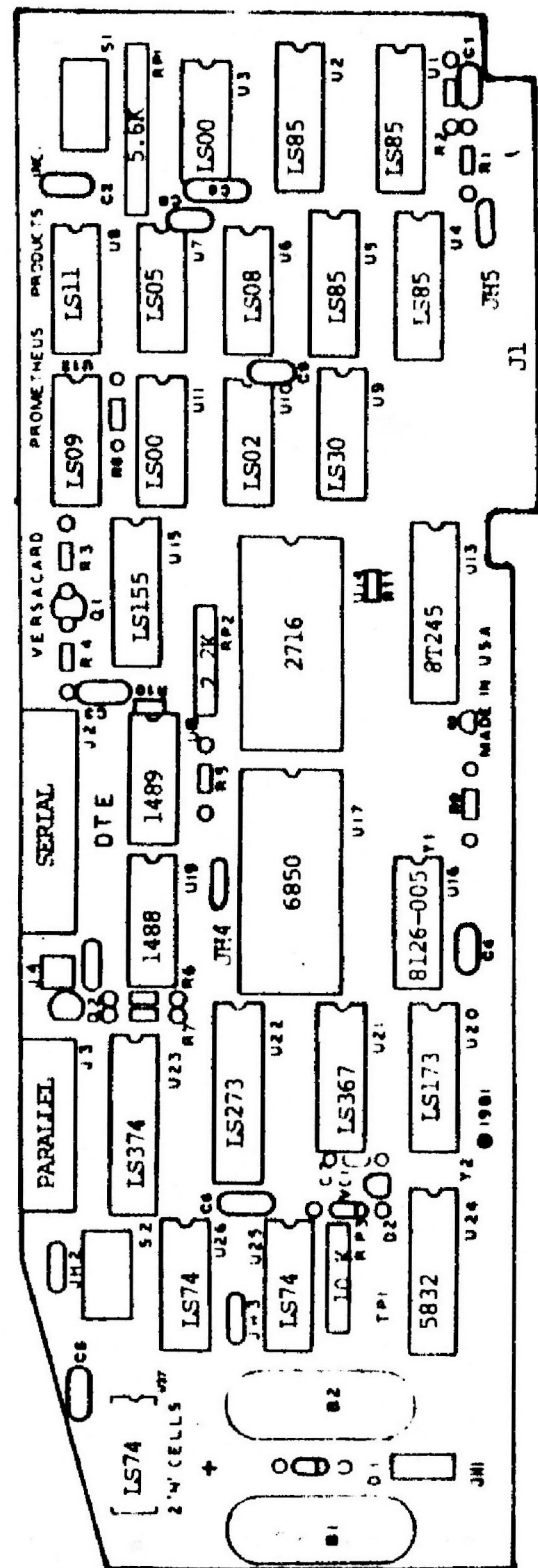

BATTERY - EVEREADY E-90  
BATTERY HOLDER - ALUM 154 B.H.  
(KEYSTONE)

## INDEX

### B

8th data bit, 27

### A

Apple IIe Computer, 7  
Apple Pascal, 26  
    Clock Interface, 8  
Applications and Diagnostics Disk, 8, 23

### B

BSR COMMAND CONSOLE, 13

### C

CP/M, 26  
    Clock Interface, 8  
Cable Installation  
    Parallel Apple IIe, 7  
    Parallel General, 6  
Cables  
    IDS Parallel Pinout, 7  
Centronics Printers  
    Parallel Cabling, 7  
Clock Assembly Language Interface, 33  
Clock Interface in CP/M and Apple Pascal, 8  
Control X, 11  
Current Loop and Teletypes, 14

### E

Enabling and Disabling Interrupts, 21  
External Terminal, 27

### F

Full Duplex, 28

### H

Half Duplex, 28

## I

- IDS Parallel Cable, 7
- Input/Output Mode Characters, 29
- Interaction with VERSAcad Firmware, 21
- Interrupts, 8
  - Problems, 21
  - Rate selection, 20
  - Use problems, 12

## L

- Lead In Character, 25

## M

- Modem, 12
- Modems, 6, 12, 27

## P

- Paging, 27
- Parallel Cable Configuration, 6
- Parallel Cables, 6
- Parallel Interface
  - Pinout, 17
  - Problems, 10
- Phantom Slots, 2
- Printer
  - Slot 1, 28
- Printers
  - 8th bit, 27
  - Parallel cabling, 7
- Problems with Interrupts, 21

## R

- RS-232C, 6, 10, 27
- Reading and setting the time, 30
- Reading and setting the year, 32
- Real Time Clock, 27
  - Accuracy, 20
  - Apple Pascal, 8
  - Assembly entry Points, 33
  - CP/M, 8, 12
  - Configuration, 8
  - Mode Characters, 29
  - Pascal, 12
  - Problems, 11
  - Programs, 12
  - Setting the Time, 31

Write Protect Switch, 33  
Wrong Time, 10

S

Serial Interface  
  Problems, 10  
Serial cable Configuration, 6  
Switch S2  
  Clock Write Protect, 33  
Syntax Error Messages, 11  
Syntax Errors, 21

I

Terminal Mode, 12

U

Ultrasonic Transducer  
  Connector, 20

V

VERSACard  
  Revision levels, 6

Z

Z-80 Cards, 19  
  Clock, 6

Prometheus Products, Inc.  
45277 Fremont Blvd.  
Fremont, CA 94538  
Sales #(415) 490-2370  
Technical #(415) 490-8101

**FOR TECHNICAL SUPPORT OR TO RETURN MERCHANDISE CALL (415)490-8101**