



Owner's Manual



Intelligent Peripheral Devices, Inc.

20380 Town Center Lane, Suite 270

Cupertino, CA 95014

Phone: (408) 252-9400

Fax: (408) 252-9409

E-mail: alphasmart@eworld.com



One Year Limited Warranty

Intelligent Peripheral Devices, Inc. warrants the AlphaSmart Pro keyboard and display to be free from defects in materials and workmanship for a period of one year from the date of original retail purchase. During this period, if a defect should occur, Intelligent Peripheral Devices will, at its option, repair or replace the AlphaSmart Pro at no charge to you, provided that it is returned during the warranty period to Intelligent Peripheral Devices or one of its authorized dealers. This warranty does not apply if the AlphaSmart Pro has been damaged by accident or abuse, or modified without the written permission of Intelligent Peripheral Devices, or if the serial number has been removed or defaced. There are no other warranties, express or implied. Intelligent Peripheral Devices accepts no responsibility for consequential damages, including but not limited to loss of profit or benefits.

Nothing in this manual may be reproduced in any manner, either wholly or in part, for any purpose whatsoever without written permission from Intelligent Peripheral Devices, Inc.

Copyright ©1995 Intelligent Peripheral Devices, Inc. All rights reserved.

Apple, the Apple logo, Apple IIGS, and Macintosh are registered trademarks of Apple Computer, Inc. Classic is a registered trademark licensed to Apple Computer, Inc. Apple Desktop Bus, Performa, and PowerBook are trademarks of Apple Computer, Inc. MacWrite is a registered trademark of Claris Corporation. Microsoft is a registered trademark of Microsoft Corporation. IBM is a registered trademark of International Business Machines.



■ TABLE OF CONTENTS

Warranty	Inside Cover
System Requirements	2
Quick Start	2
Safety, Care, and Maintenance	3
Entering Text	4
Working with Files	5
Data Recovery	6
Sending Text to a Macintosh	6
Sending Text to a PC	8
Changing the Transfer Speed	10
Installing the ADB "Y" Cable	11
Concerns About ADB Live Connect/Disconnect	12
Batteries and Power Requirements	13
Radio and Television Interference	15
Troubleshooting	16
AlphaSmart Accessories	18
TurboTransfer Software	19



■ SYSTEM REQUIREMENTS

The AlphaSmart Pro works with virtually any desktop computer, whether IBM compatible or Apple Macintosh.

The AlphaSmart Pro works with any Apple® computer equipped with an Apple Desktop Bus™ (ADB) port, which includes the Apple IIGS®, all Macintosh® models*, all PowerBook™ models, the Performa™, Centris™, and Quadra™ series, and all Power Macintosh models.¹ AlphaSmart is compatible with all Apple system software versions 6.0.x and later, including System 7.x.

The AlphaSmart Pro also works with IBM compatible computers including PC AT, PS/2, 286, 386, 486, and Pentium.² AlphaSmart Pro is compatible with all versions of DOS, Windows and OS/2.

***Note for Macintosh Users:** For the sake of simplicity, the term “Macintosh” is used generically throughout this manual. The procedures are the same regardless of the particular Macintosh model being used.*

***Note for PC Users:** For the sake of simplicity, the term “PC” is used generically throughout this manual when referring to an IBM-compatible DOS, Windows or OS/2 personal computer. The procedures are the same regardless of the particular IBM compatible model being used.*

■ QUICK START

For those of you who don't like to read manuals, here's a quick guide to working with the AlphaSmart Pro keyboard and display.

***Note:** It is important to follow these steps completely in the order they are given.*

¹AlphaSmart does not work with older, non-ADB-based Macs, including the Mac 128, Mac 512, Mac 512E, and Mac Plus. It is compatible with the Mac SE and all Macs produced after the Mac SE.

²AlphaSmart is not currently compatible with the older XT model PCs.



Step One—Using AlphaSmart

- Turn on the AlphaSmart and start typing. Your text will appear in the window.
- Use the arrow keys when needed to move your cursor in the text.
- Use the **Delete** key to erase.

Step Two—Transferring Text to a Computer

- Turn on the Macintosh or PC
- Start up your word processing application and open a new file.
- **Mac:** Unplug the cable from the Macintosh keyboard³ and plug it into the AlphaSmart.
- **PC:** Unplug your keyboard from the PC. Using a PC-to-AlphaSmart cable, plug one end into the PC keyboard port and the other end into the AlphaSmart. See the section “Sending Text to a PC” for more detailed instructions.
- Press the **Send** key on the AlphaSmart. Your text will appear on the Macintosh or PC screen.
- Disconnect the cable from the AlphaSmart and reconnect the regular keyboard to the computer.

Step Three—Finishing the Process

- At the Macintosh or PC, save the new file.
- At the AlphaSmart, press the **Clear File** key to erase the text.

AlphaSmart supports eight different files. To go to File 1, press the **F1** key. Press **F2** to go to File 2, and so on up to **F8** for File 8.

■ SAFETY, CARE & MAINTENANCE

With proper care and maintenance, your AlphaSmart will give you years of worry-free service.

- Turn off the AlphaSmart when it is not in use.
- Always turn off your AlphaSmart before changing the batteries or connecting to an AC adapter.
- Take care not to break the LCD screen. Don't drop the AlphaSmart or subject it to strong impact.

³See the Installing the ADB “Y” Cable section for information on an even faster and more convenient connection.

- 
- Keep your AlphaSmart away from extreme heat. Don't leave it on the dashboard or in the trunk of a car, or near a heater.
 - Don't leave your AlphaSmart in a place that is extremely dusty or damp.
 - Do not use frayed or damaged cables.
 - Never force a connector into a port if the connector and port do not join easily.
 - Clean the screen only with a soft dry cloth. Do not use solvents.
 - Do not stack one AlphaSmart Pro on top of another.

Caring For Batteries

- Turn off the AlphaSmart when you are finished. This conserves battery life.
- To avoid battery leakage, change the batteries as soon as they become weak.
- Do not drop, puncture, disassemble, mutilate or incinerate the batteries.
- Recharge only rechargeable batteries, and then only as directed in the manual.
- Do not leave batteries in hot locations.

■ ENTERING TEXT

When you first turn on your AlphaSmart, you will see the splash screen (AlphaSmart v2.0x) for a few seconds, and then a blank screen. To enter text, simply begin typing as you would on any other keyboard. Use the Delete key to erase. The arrow keys allow you to move your cursor through the text. Additionally, the following keyboard combinations will also move your cursor as specified:

- ⌘↑ moves the cursor up 4 lines (one displayed page)
- ⌘↓ moves the cursor down 4 lines (one displayed page)
- ⌘→ moves the cursor to the end of the line
- ⌘← moves the cursor to the beginning of the line

As with any word processing application, the text will automatically wrap at the end of each line, so you should use the Return key only to separate paragraphs.

All text formatting, including margins, tab stops, font, size, and other styling attributes, are done on the desktop com-



puter after the file has been transferred from the AlphaSmart. Only the characters themselves (ASCII key codes) are transferred from the AlphaSmart to the computer. However, the Tab key can be used on the AlphaSmart to create columns or paragraph indentations which will transfer to the Macintosh with the file. When the tab key is used, it will appear as a right arrow on the AlphaSmart screen.

The AlphaSmart does not have cut, copy, paste, or spelling checker functions included. These advanced editing features are more easily performed when using a larger screen and mouse, and therefore should be performed once a file has been transferred to the desktop computer.

When an AlphaSmart file is full, a message will display which reads:

File is full. Use another file or send data to your computer.

Caps Lock Indicator

When Caps Lock is active, the lower right character of the screen will be solid black. Pressing the Caps Lock key toggles the Caps Lock on and off.

■ WORKING WITH FILES

The first time that the AlphaSmart is turned on, it will display the message *Opening File 1*. On subsequent startups, it will automatically open the last file used.

The AlphaSmart Pro supports eight files, which are fixed in length. File 1 is 16 pages long, files 2–5 are 8 pages each, files 6 and 7 are 6 pages each, and file 8 is 4 pages in length. This provides a total storage capacity of 64 pages of text or 128,000 characters.

This file structure is intended to support multiple users or to enable a single user to organize his or her work into chapters or sections.

To move between files, press F1 to go to File 1, F2 to go to File 2 and so forth, up to F8.

Text entered into each AlphaSmart file will remain there until you explicitly erase it by pressing the **Clear File** key



when the AlphaSmart is not attached to a desktop computer. Note that when you press the Clear File key, you are clearing only the file in which you are currently working; other files will remain unchanged.

Once the Clear File key is pressed and file is deleted, information may still be recovered using the Data Recovery command described below. However, for confidential files which you wish to erase without the ability to recover, you may press **⌘-Option-Clear File**. This command writes 0 (zeros) to the entire file. Use this command with care.

■ DATA RECOVERY

If you accidentally clear a file, it can still be recovered as long as no text has been entered into that file yet. Open the file you wish to recover by pressing one of the F1–F8 keys. Press **⌘-Option-R** to activate the AlphaSmart Emergency Data Recovery Command.

This command restores the currently open file by setting the end of file marker at the maximum length of the file. This can, however, have some disconcerting consequences. For example, if you have typed in only half a page of text in File 1, the utility will restore the full 16-page capacity of the file, appending whatever was in memory at the end of your original file. If this happens, simply go to the end of the file and hold down the **Delete** key until you erase all of the garbage. You can also connect your AlphaSmart to a computer, press the **Send** key to transfer the restored file, and then abort the transmission at the appropriate time by pressing any other key.

Note: If the file was deleted using the ⌘-Option-Clear File command, the data is not recoverable.

■ SENDING TEXT TO A MACINTOSH

One of the connectors on the right side of the AlphaSmart is the PC port and the other is the Mac ADB port. (If you need two ADB ports, use the Y cable to provide the other ADB port.) The IBM compatible port is labeled “PC” and the Macintosh ADB port is labeled “Mac/IIGS.”



When you attach your AlphaSmart to a Macintosh, the AlphaSmart changes modes and the screen displays the following message:

*Attached to Macintosh, emulating keyboard.
Press Send Key to transfer file.*

If you do not see this message, check your cable and make sure it is attached properly to the Macintosh.

When the AlphaSmart is attached to a Macintosh, all of the keys except the Send key behave as standard Macintosh keyboard keys. Any characters that are typed will appear on the Macintosh screen, and the Clear File key acts as a Macintosh clear key. Although the Pause/PrtScn, NumLk/ScrLk, ins/del, Control, and Option keys have no function when the AlphaSmart is used in standalone mode, they function as normal Macintosh keys when the AlphaSmart is plugged into a Macintosh (The Pause/PrtScn acts as F9, NumLk/ScrLk as F10, and ins/del as F11 when attached to a Mac).

To change files when attached to the Macintosh, press **⌘-Option-F1** to go to File 1, **⌘-Option-F2** to go to File 2, and so on.

Pressing the Send key (at the extreme upper right of the keyboard) initiates the transfer of the current file from the AlphaSmart to the Macintosh. If you want to abort a file transfer, just press any other key.

When the transfer is complete, disconnect the AlphaSmart. (You may also leave the AlphaSmart connected to the Macintosh for use as a normal keyboard.) Reconnect your normal Macintosh keyboard after the AlphaSmart has been disconnected.

To finish the transfer process, save the word processing file on the Macintosh. Once the text is saved on your Macintosh, you can style, format, and spell check the file as you would any other file in your word processing application.

To erase the transferred file from the AlphaSmart, press the **Clear File** key on the AlphaSmart. The currently displayed file will be deleted.

■ SENDING TEXT TO A PC

One of the connectors on the right side of the AlphaSmart is the PC port and the other is the Mac ADB port. (If you need two ADB ports, use the Y cable to provide the other ADB port.) The IBM compatible port is labeled "PC" and the Macintosh ADB port is labeled "Mac/IIGS."

Attaching to a PC

Unlike the Mac, PCs only allow one keyboard device to be attached at the same time. To connect the AlphaSmart, unplug the PC keyboard from your desktop PC. Plug a keyboard extension cable (provided in the cable kit) into your desktop PC. Using the PC-to-AlphaSmart cable, connect your AlphaSmart to the extension cable.

When you have finished transferring your files, reconnect your PC keyboard to the extension cable. [The extension cable is optional—it is provided as a convenience so that you don't have to reach behind your PC to connect/disconnect your keyboard cables. If your desktop PC has its keyboard port in a convenient spot, the keyboard extension cable is not needed.]

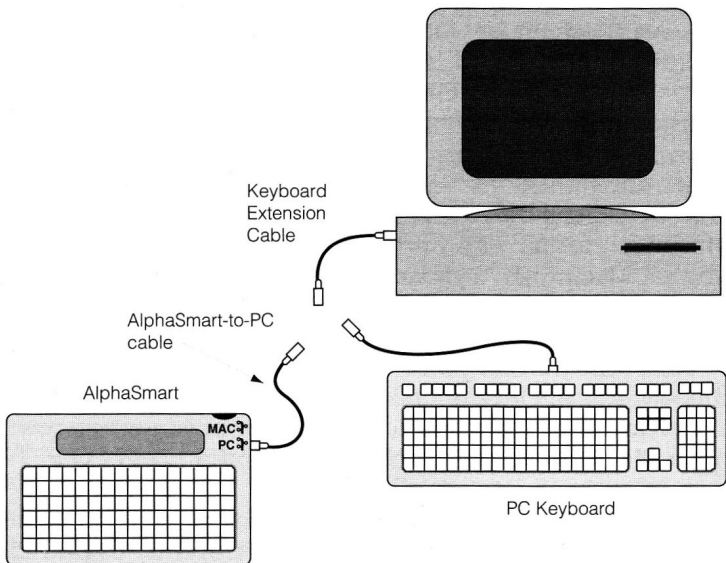



Figure 1. Attaching the AlphaSmart Pro to a PC



When you attach your AlphaSmart to a PC, the AlphaSmart changes modes and the screen displays the following message:

*Attached to PC, emulating keyboard.
Press Send Key to transfer file.*

If you do not see this message, check your cable and make sure it is attached properly to the PC.

When the AlphaSmart is attached to a PC, all of the keys except the Send key behave as standard PC keyboard keys. Any characters that are typed will appear on the PC screen. Although the Escape, Enter, Control, Pause/PrtScn, NumLk/ScrLk, Ins/Del, and Alt keys have no function when the AlphaSmart is used in standalone mode, they function as normal PC keys when the AlphaSmart is plugged into a PC.

When the AlphaSmart is attached to a PC

⌘-Pause/PrtScn is the same as F9

⌘-NumLk/ScrLk is the same as F10

⌘-ins/del is the same as F11

⌘-clear file is the same as F12

Shift-Pause/PrtScn is the same as a pause character

Shift-NumLk/ScrLk is the same as NumLk

Shift-ins/del is the same as insert

Important: *The AlphaSmart **must** be turned on before the PC in order for the PC to boot when it is attached as the PC keyboard.*

To change files when attached to the PC, only press the ⌘ key and the **Fx** key (F1 for file 1, F2 for file 2, etc). Do not press the Alt/Option key. Pressing the Alt key puts some word processing programs into command mode and the file won't transfer correctly.

Pressing the Send key (at the extreme upper right of the keyboard) initiates the transfer of the current file from the AlphaSmart to the PC. If you want to abort a file transfer, just press any other key.

When the transfer is complete, disconnect the AlphaSmart. (You may also leave the AlphaSmart connected to the PC for use as a normal keyboard.) Reconnect your normal PC keyboard after the AlphaSmart has been disconnected.

To finish the transfer process, save the word processing file on the PC. Once the text is saved on your PC, you can style, format, and spell check the file as you would any other file in your word processing application.

To erase the transferred file from the AlphaSmart, press the **Clear File** key on the AlphaSmart. The currently displayed file will be deleted.

Identifying Your PC Keyboard Port

Unlike the Macintosh, where a separate connection cable is optional, a separate connection cable is required when connecting the AlphaSmart to a PC.

When ordering cables to connect an AlphaSmart to a PC or IBM compatible computer, you must specify whether you need the 5-pin or 6-pin style Connection Cable Set. To find out what type your PC keyboard port is, remove the keyboard cable from your PC and compare its end to the examples in Figure 2.

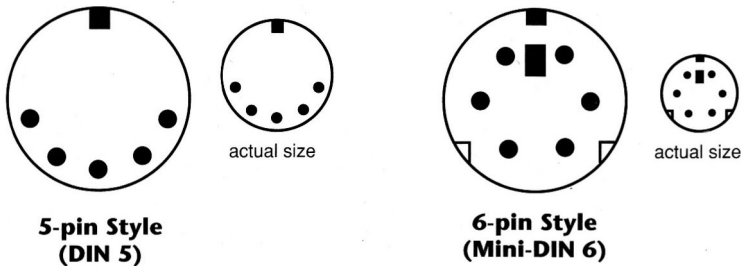



Figure 2. Which one does your PC keyboard port look like?

The Connection Cable Set consists of two cables, an AlphaSmart-to-PC cable and a Keyboard Extension cable. While only the AlphaSmart-to-PC cable is necessary to connect the AlphaSmart to your PC, the second, a Keyboard Extension cable, is included to make reconnection of your keyboard easier and more convenient. Refer to Figure 1 to see how to connect the two cables to your PC.

■ CHANGING THE TRANSFER SPEED

Although it is not necessary to change the AlphaSmart file transfer speed from the default, it does come equipped with



four different file transfer speeds. The AlphaSmart file transfer speed menu is accessed by the keyboard command **⌘-Option-S**. The speed command affects both the Mac sending speed and the PC sending speed.

The AlphaSmart has four file transfer speeds:

1. *Very Slow* is the slowest speed setting and is compatible with all machines and applications. It is recommended especially when you are using KIDWORKS™ or The Children's Writing Center.
2. *Slow*, the default setting, is compatible with all machines and most applications. It is recommended especially if you are using a Mac Classic, an Apple IIGS or a PC AT (286).
3. *Faster*, which is a little faster and is recommended for the Mac LC or for 386- and 486-based PCs.
4. *Fastest* is the fastest speed setting. However, some word processing programs may experience a loss of data when files are transferred using this mode, so you may wish to experiment to see which speed works best for you.

Note: *The keyboard control panel in your Macintosh system may also need to be adjusted to a faster setting.*

If you are using a Mac, you can significantly speed up the transfer of data (approximately 10 times faster) by using TurboTransfer software (see details under *TurboTransfer Software*).

■ INSTALLING THE ADB “Y” CABLE

You may use any Apple Desktop Bus (ADB) cable to transfer data from the AlphaSmart to the Macintosh—no special cable is usually needed. For convenience, however, we offer an optional “Y” cable that makes connecting and disconnecting an AlphaSmart even easier. We suggest installing the “Y” cable between your keyboard and its ADB cable, as shown in Figure 3.

⁴The ADB “Y” cable is required when connecting to a Macintosh with an “Apple Design Keyboard,” model #M2980, since this keyboard has an attached ADB cable and only one ADB connector.

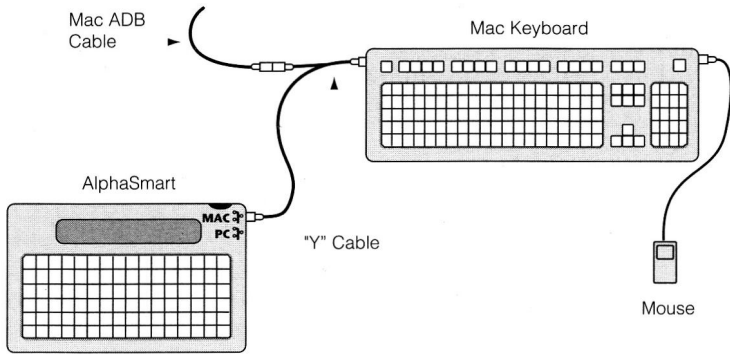

Figure 3. Installing the "Y" Cable

To install the "Y" cable, first disconnect your Macintosh keyboard from the computer. Insert the trunk of the "Y" cable into the empty ADB port on the keyboard.

Plug the short leg of the "Y" cable into your original keyboard cable. The remaining cable leg will be used to connect your AlphaSmart to the Macintosh when you want to transfer text.

Warning: *DO NOT attach the AlphaSmart to both the PC and the Mac at the same time. It won't work and possible damage may occur to the Mac or the PC.*

■ CONCERNS ABOUT ADB LIVE CONNECT/DISCONNECT

The AlphaSmart keyboard is designed to be connected to and disconnected from Macintosh ADB ports while the Mac is running.

Some people may be concerned with this, since Apple recommends not unplugging or attaching an ADB device while the computer is running. This is recommended by Apple because certain ADB devices change modes when they are unplugged, causing confusion to the system when the devices are reattached.⁵

⁵As stated on page 290 of *The Guide to Macintosh Family Hardware* by Apple Computer (published by Addison-Wesley): "Do not unplug and reattach an ADB device while the computer is running—if you do, the device reverts to its default address while the computer continues trying to reach the device at the address assigned at startup time."



However, the AlphaSmart has been designed so that it does not change modes when unplugged. More importantly, it does not confuse the Mac when unplugged and reconnected.

■ BATTERIES AND POWER REQUIREMENTS

Batteries

The AlphaSmart runs on two AA batteries of the same type (alkaline, carbon, or NiCad). The longest battery life will be achieved with alkaline batteries. Good quality AA alkaline batteries will power the AlphaSmart for 60–120 hours. (When the AlphaSmart is turned off, no power from the AA batteries is used.)

Rechargeable NiCad Battery Pack

For convenience, you may purchase an AlphaSmart rechargeable NiCad battery pack (see the AlphaSmart Accessories section for a complete description). When the rechargeable NiCad battery pack is installed into your AlphaSmart, it is automatically re-charged whenever the AC adapter is plugged in, or when your AlphaSmart is attached to a Macintosh or PC. The NiCad battery pack is charged regardless of whether the AlphaSmart is turned on or off.

You will get the longest life from your NiCad battery pack if you do shallow discharge/charge cycles. (NiCad cells have a 500–cycle lifetime if fully discharged and charged, but have over a 1,000–cycle lifetime if the discharge/charge cycles are less than 50% of capacity.) The memory effect will also be avoided if the length of the discharges is somewhat random.

Complete charging of a discharged battery pack takes 16 hours. The best charging strategy is to recharge the NiCad pack overnight after 8–15 hours (1–3 days) of use. A fully charged NiCad pack will power the AlphaSmart for 20–50 hours, depending on use.

Conditioning

New NiCad batteries require 3–5 charge/discharge cycles before reaching their full rated capacity. For the longest run time, charge and fully discharge your new battery pack three times to achieve the full rated capacity.

Fully discharge your NiCad battery pack by leaving the AlphaSmart turned on until the screen is so dim you can't



read it anymore. Do not leave the AlphaSmart turned on past this point, as it may damage the NiCad cells.

Re-conditioning

After about 30 charge/discharge cycles, fully discharge your NiCad battery pack before changing to avoid the ugly memory effect.

Storage

NiCad batteries which are not used over time lose their charge and should be recharged before use. Always fully charge your battery before you use it after it has been stored for more than one week at a time.

Lifetime

Don't expect rechargeable batteries to last forever. Well maintained NiCad batteries last about 500 charges or about 3 years. If your battery used to last 40 hours but now only lasts 1 hour, it's time for a new battery.

Note: If your batteries are dead and you have no AC adapter, you can still send your data to your Macintosh or PC. Simply attach the AlphaSmart to the Macintosh or PC and turn it on. The keyboard cable supplies power to run the AlphaSmart while attached. You can't do any editing, but you can transfer the data in your files.

Toxic Elements Statement

Each cell is a sealed container enclosing a nickel electrode, a cadmium electrode and potassium hydroxide electrolyte. The electrolyte is caustic. Avoid contact with skin or eyes. If accidentally exposed, flush eyes with water immediately.

Do not incinerate or mutilate the battery, as this may cause it to burst or release toxic materials. Do not short circuit, as this may cause burns. Please dispose in accordance with local, state, and federal regulations.

Low Battery Indication

When your AA batteries or NiCad battery pack is getting low, a message will flash on your screen:

Low Battery!!

The Low Battery message will appear 15 minutes to 1 hour before the batteries are dead.

Lithium Battery

AlphaSmart also uses a secondary backup battery that is not user-accessible. This 3V lithium coin cell battery powers the memory, preventing data loss when the unit is turned off and the primary AA or NiCad batteries are dead. This lithium battery should be good for approximately 5–10 years. It is mounted in a socket and may be replaced by authorized service personnel. To determine if the 3V lithium battery has been discharged:

1. Enter some text into the AlphaSmart.
2. Turn the unit off.
3. Remove the AA batteries and make sure the unit is not plugged into the AC adapter or attached to a Macintosh.
4. Wait two minutes.
5. Turn the unit back on. If the text you entered is still there, then the lithium battery is still good. If the text has disappeared and the screen is blank, then the lithium battery has been discharged and should be replaced.

To replace the lithium battery, you must take the case apart. The lithium battery used is CR2032. Please dispose of the discharged lithium battery properly.

Power

When connecting the AlphaSmart to a Macintosh, do not connect the AC adapter. Using the AC adapter is not necessary as the AlphaSmart will use the power available in the ADB cable, even if no batteries are installed.

The DC power jack input will accept a voltage 9 to 12 V DC with a minimum current rating 100mA. Off-the-shelf AC adapters may be used at your own risk.

Full testing was done with the AC adapter from Intelligent Peripheral Devices and use with any other AC adapter is not guaranteed. If damage occurs because of use with another AC/DC adapter, repair is not covered under the warranty.

■ RADIO AND TELEVISION INTERFERENCE

This equipment has been tested and found to comply with the limits for a Class B digital device, pursuant to Part 15 of the FCC Rules. These limits are designed to provide reasonable protection against harmful interference in a residential installation.



This equipment generates, uses, and can radiate radio frequency energy and if not installed and used in accordance with the instruction manual, may cause harmful interference to radio communication. However, there is no guarantee that interference will not occur in a particular installation.

If this equipment does cause harmful interference to radio or television reception, which can be determined by turning the equipment off and on, the user is encouraged to try to correct the interference by one or more of the following measures:

- Reorient or relocate the receiving antenna
- Increase the separation between the equipment and the receiver
- Connect the equipment into an outlet on a circuit different from that to which the receiver is connected
- Consult the dealer or an experienced radio/TV technician for help.

Note: *Use of shielded power and interface cables with this equipment is required in order to ensure compliance with FCC specifications.*

Caution: *Changes or modifications to this equipment not expressly approved by the manufacturer responsible for compliance could void the user's authority to operate the equipment.*

■ TROUBLESHOOTING

The following is a list of difficulties you may encounter while using AlphaSmart, and the solutions to these common problems.

Nothing appears on the AlphaSmart screen when I turn it on.

- Check your batteries. Plug your AlphaSmart into the AC adapter—if it turns on, your batteries are discharged or have been improperly inserted. Make sure the batteries are oriented as indicated in the battery cavity.
- If the screen is blank, except for a flashing cursor in the upper left corner of the screen, then you are simply in an



empty file. Start typing and characters should appear on your screen.

When I start up the AlphaSmart, I see something other than the file that I expected.

- Make sure you are in the correct file. AlphaSmart supports eight different files. To change files, press **F1** to go to File 1, **F2** to go to File 2, and so on.

I try to type into a file, but no characters show up.

- If the file looks empty, press the **Clear File** key to make sure the file is erased. Then try typing again. (Sometimes the file recovery command **Option-⌘-R** gets hit by mistake, filling up the file so that you can't type any more into it. See the Data Recovery section for more details.)
- If you can't see the cursor on the screen, then your batteries may be too low. Check your batteries or plug in your AC adapter.

My file is full of garbage/The end of my file is full of garbage.

- If you have no useful text in the file, just press the **Clear File** key to erase the entire file.
- If you have some data you would like to save, go to the end of the file by pressing the **End** key and then hold down the **Delete** key until you erase all the unwanted text.

How did all that garbage get there?

- Sometimes the file recovery command (**Option-⌘-R**) gets hit by accident. This command will recover ALL data, including any garbage in memory at the end of your files. See the Data Recovery section for more details.

When I turn my AlphaSmart on and off quickly, weird characters show up on the display.

- Turn your AlphaSmart off for at least 5 seconds and then turn it back on. Your screen and your data should appear correctly. Always turn off your AlphaSmart when changing batteries or inserting the AC adapter into the jack.



When a file is transferred to the Macintosh, some of the characters do not show up or appear not to have transferred.

- Disconnect the AlphaSmart from the Macintosh and check the file transfer speed by pressing **Option-⌘-S**. Reset the AlphaSmart to a slower setting (speed 1 is the slowest).
- Try using a different word processing program. Some programs allow the AlphaSmart to transfer data faster than others.
- Adjust the keyboard control panel in the Macintosh system to a faster speed to maximize the file transfer speed.

■ ALPHASMART ACCESSORIES

To make your AlphaSmart even more useful and convenient to use, Intelligent Peripheral Devices, Inc. offers several accessories, some of which you may have received with your AlphaSmart. See your dealer for information on pricing and bundling.

AC Adapter

This allows the AlphaSmart to be used when its batteries are either discharged or not available. It is also used to charge the NiCad Rechargeable Battery Pack, when it is installed in an AlphaSmart.

Carrying Case

This black denier polyester carrying case protects the AlphaSmart from damage during moving or storage. It also has a small handle for carrying convenience.

ADB "Y" Cable

This cable streamlines the process of connecting the AlphaSmart to your Macintosh by making it unnecessary to disconnect the Macintosh keyboard every time you want to transfer a file. See the section *Installing the ADB "Y" Cable* for more information.

The ADB "Y" cable is required when connecting to a Macintosh with an "Apple Design Keyboard," model #M2980, since this keyboard has an attached ADB cable and only one ADB connector.

NiCad Rechargeable Battery Pack

This pack eliminates the need to buy batteries. It is installed in the battery compartment and replaces the two AA batteries. With normal use, you will need to recharge the battery pack only once a week, using the AC adapter described above. When the AlphaSmart is either plugged into the AC adapter or attached to the Macintosh, it is recharging the battery pack.

5-pin AlphaSmart-to-PC Cable Set

Consists of two cables, a keyboard extension cable (6 foot DIN-5 male to DIN-5 female) and a 5-pin AlphaSmart-to-PC cable (3 foot DIN-5 male to Mini-DIN-6 female).

6-pin AlphaSmart-to-PC Cable Set

Consists of two cables, a keyboard extension cable (6 foot Mini-DIN-6 male to Mini-DIN-6 female) and a 6-pin AlphaSmart-to-PC cable (3 foot Mini-DIN male to Mini-DIN-6 male).

Note: Either the "AT" or "PS/2" cable set is required to attach the AlphaSmart to a PC.

■ TURBOTRANSFER SOFTWARE DISK

For Mac users who write frequently, you can significantly speed up the transfer of data (approximately 10 times faster) by using TurboTransfer software.

The TurboTransfer software disk contains an extension (file) that you need to "drop" into the System folder on your Macintosh. When you do so, the Mac will prompt you with the following message:

Extensions need to be stored in the Extensions folder in order to be available to the Macintosh. Put "TurboTransfer 1.x" into the Extensions folder?

Click OK and **restart the computer** with the AlphaSmart disconnected in order to load the extension. Now you are ready to download at turbo speeds!

To deactivate this extension, simply drag it out of the Extensions folder (within the System folder) onto the desktop and **restart the computer**.



