

# RamKeeper<sup>TM</sup>

---

## User's Manual

**AE** APPLIED ENGINEERING<sup>TM</sup>

A DIVISION OF AE RESEARCH CORPORATION

v2.0

## **Federal Communications Commission Radio Frequency Interference Statement**

The equipment described in this manual generates and uses radio frequency energy. If it is not installed and used properly, that is, in strict accordance with these instructions, it may cause interference to radio or television reception.

### **FCC I.D. Number: EY5QGRAMKEEPER**

This equipment has been type tested and found to comply with the limits for a Class B computing device in accordance with the specifications in Subpart J of Part 15 of the FCC Rules. These rules are designed to provide reasonable protection against radio and television interference in residential installation.

However, there is no guarantee that interference will not occur in a particular installation. If this equipment does cause interference to radio or television equipment off and on, the user is encouraged to try to correct the interference by one or more of the following measures:

- ◇ Reposition the receiver's antenna. Also make sure the antenna wires are making good electrical contact.
- ◇ Use a roof-mounted antenna rather than a "rabbit-ear" antenna or an antenna mounted in the attic.
- ◇ Make sure that all electrical connections on the computer are secure and any shielded I/O cables are properly fastened.
- ◇ Move the computer away from the receiver.
- ◇ Plug the computer and receiver into separate electrical circuits.

If necessary, the user should consult the dealer or an experienced radio/television technician for additional suggestions. The user may find the following booklet prepared by the Federal Communications Commission helpful:

“How to Identify and Solve Radio-TV Interference Problems”

This booklet is available from the U.S. Government Printing Office, Washington, D.C. 240402, Stock No. 004-000-00345-4.

**Warning:** This equipment has been certified to comply with the limits for Class B computing device, pursuant to Subpart J of Part 15 of FCC Rules. Only peripherals (computer input/output devices, terminals, printers, etc.) certified to comply with the Class B limits may be attached to this computer. Operation with non-certified peripherals is likely to result in interference to radio and TV reception.

Applied Engineering is not responsible for any radio or television interference caused by unauthorized modifications to this equipment. It is the responsibility of the user to correct such interference.

Use only the battery, battery cable, and transformer supplied with this product. Substitute items may cause interference problems.

## Limited Warranty & Disclaimer

---

Applied Engineering warrants the RamKeeper and SlotMover against defects in material and workmanship for a period of 5 years from the date of original retail purchase and warrants the Gel/Cell battery against defects in material and workmanship for a period of 1 year from the date of original retail purchase. Applied Engineering also warrants that, under normal use, the magnetic media on which the software is stored is free from defects in materials and workmanship for a period of 30 days from the date of original purchase. Any misuse, abuse, or non-authorized alteration, modification and/or repair to the Applied Engineering product will void the warranty. This warranty will also be void if you use the /E product for any other purpose than its intended use. If you discover a defect, Applied Engineering will, at its option, repair or replace only the Applied Engineering product, provided you return the product during the warranty period, transportation prepaid, to Applied Engineering.

**This warranty applies to the original retail purchaser only.** Therefore, please include a copy of the original invoice or a small service charge may be applied. If the product is to be Sent to Applied Engineering by mail, the purchaser will insure the package or assume full responsibility for loss or damage during shipping. Prior to returning the product for warranty consideration, call Applied Engineering Technical Support for a Return Material Authorization (RMA) number and shipping instructions.

---

Even though Applied Engineering has tested the software and reviewed the documentation, Applied Engineering makes no warranty or representation, either express or implied, with respect to the manual or the software; their quality, performance, merchantability, or fitness for a particular purpose. As a result, the software and manual are sold "as is," and you, the purchaser, are assuming the entire risk as to their quality and performance.

In no event will Applied Engineering be liable for loss or damages of any kind caused either directly or indirectly by the use or possession of its products, even if advised of the possibility of such damages. The Applied Engineering Warranty is for the Applied Engineering Product itself. In particular, Applied Engineering shall have no liability for any other equipment used in conjunction with Applied Engineering products nor for programs or data stored in or used with Applied Engineering products, including the costs of recovering such equipment, programs, or data.

The warranty and remedies set forth above are exclusive and in lieu of all others, oral or written, express or implied. No Applied Engineering dealer, agent, or employee is authorized to make any modification, extension, or addition to this warranty.

Some states do not allow the exclusion or limitation of implied warranties or liability for incidental or consequential damages, so the above limitation or exclusion may not apply to you. This warranty gives you specific legal rights, and you may also have other rights which may vary from state to state.

---

This manual and the software (computer programs) described herein are copyrighted by Applied Engineering with all rights reserved. Under the copyright laws, this manual or the programs may not be copied, in whole or in part, without the written consent of Applied Engineering, except in the normal use of the software or to make an archival copy. This exception does not allow copies to be made for others, whether or not sold, but all of the materials purchased (with all archive copies) may be sold, loaned, or given to another person. Under the law, copying includes translating into another language or format. You may use this software on any computer owned by you but extra copies cannot be made for this purpose.

Applied Engineering cannot guarantee that you will receive notice of revisions to the software documentation or products described in this manual. Be sure to check with your dealer or Applied Engineering for information on possible updates. However, Applied Engineering reserves the right to make any improvements to Applied Engineering products without any responsibility toward upgrading previously released products.

---

Apple and Apple IIGS are registered trademarks of Apple Computer, Inc.

AppleWorks, Apple IIGS Memory Expansion Card, DOS 3.3, and ProDOS are trademarks of Apple Computer, Inc.

Applied Engineering and RamWorks are registered trademarks of Applied Engineering.

Super Desktop Expander, AW 2 Expander, RamFactor, RamCharger, RamKeeper, Back Pocket, SlotMover, GS-RAM, and GS-RAM Plus are trademarks of Applied Engineering.

IIGS System Saver is a trademark of Kensington Microware, Ltd. RamPak 4Gs is a trademark of Orange Micro, Inc. RamStackPlus is a trademark of AST Research, Inc. OnBoard is a trademark of OnThree, Inc. OctoRAM is a trademark of MDIdeas, Inc. Radio Shack is a registered trademark of Tandy Corporation.

---

©Copyright 1988, Applied Engineering

---

Applied Engineering  
P.O. Box 5100  
Carrollton, Texas 75011

Sales: (214) 241-6060 9 AM - 11 PM (CST) 7 days

Technical Support: (214) 241-6069 9 AM - 12:30PM & 1:35PM - 5 PM (CST) Monday - Friday  
(The Technical Support telephone lines cannot be accessed through the Sales department.)

# Table Of Contents

---

<b>Introduction . Welcome to the Memory</b>	<b>v</b>
---	----------

---

<b>Chapter One Getting Started</b>	<b>1</b>
Required	1
Recommended	1
Possible Combinations	2
One Memory Card on RamKeeper	2
Two Memory Cards on RamKeeper	3
Installation	4
Connecting GS-RAMs to the RamKeeper's Front	8
Attaching the Optional SlotMover	11
Connecting Cards to the Back of RamKeeper	12
The "Double Boot"	15
What Now?	16
Experienced Users	16
Others	16

---

<b>Chapter Two RamKeeper Firmware</b>	<b>17</b>
About The Firmware	17
Loading the Firmware	17
Accessing the Firmware	20
Initialize ROM Disk	21
Setting the ROM Disk Size	22
Change ROM Disk Size	23
More than 2 Meg	24
ROM Disk Memory Test	24
RAM Memory Test	25
Memory Map	26
Checksum	27
About RamKeeper...	28
Quit	28

<b>Chapter Three Using the ROM Disk</b>	<b>29</b>
Copying Files to the ROM Disk	29
Location of the ROM Disk	29
Slot 2 Consideration	30
Drive Access Chart	31
ROM Drive as the Boot Device	32
<hr/>	
<b>Chapter Four The RamKeeper Power</b>	<b>33</b>
The Lights	33
Battery	34
Transformer	34
<hr/>	
<b>Chapter Five A Brief RAM/ROM Tutorial</b>	<b>35</b>
ROM is...	35
RAM is...	35
<hr/>	
<b>Chapter Six Memory Allocation</b>	<b>37</b>
Why not use all memory as a ROM Disk?	37
Is a RAM Disk now obsolete?	37
RAM and the GS Control Panel	38
<hr/>	
<b>Chapter Seven - Æ Cache</b>	<b>39</b>
Requirements	39
Installing the Cache	39
ProDOS 8	39
ProDOS 16	40
Setting the Cache Size	41
Setting the RAM Buffer Size	42
Removing the Cache	42
About the Cache	42
Copy Protected Programs	43

---

<b>Chapter Eight AW 2 Expander</b>	<b>45</b>
Before You Even Think of Modifying AppleWorks...	45
AppleWorks Modification Instructions	46
Setting the AppleWorks Enhancement Options	47
About the New Features	49
More Word-Processor Lines and Database Records	49
Clipboard Expansion	49
Printer Buffer Option	49
Buffer Size Option	49
Time Display/Database Time-Stamp Option	50
Multiple-Disk Save	51
Saving Multiple Files to Disk	51
Adding Multiple Disk Files to the Desktop	52
Print-File Cache	52

---

<b>Appendices</b>	<b>53</b>
A: Trouble Shooting	53
B: A Brief ProDOS Tutorial	55
C: Copying Disks with Filer	58
D: Bird's Better 'Bye'	59
E: Getting Help	60



## Welcome to the Memory...

**S**O you want the most user friendly computer to be even more friendly? You did the right thing. If you already own an Applied Engineering RamFactor™ with RamCharger™ battery backup, you know the convenience of having your favorite programs already loaded into memory and ready to run as soon as you boot your computer. If you haven't had this pleasure, now's your chance.

**T**URN off your computer without turning off the memory; RamKeeper™ will battery back one or two IIgs memory expansion cards giving you instant access to programs stored in ROM. Simply stated: You can turn on your computer and enter your favorite programs in seconds without having to insert and flip disks.

**E**LEPHANTS can't compete with the amount of memory available through RamKeeper. Two cards connected to RamKeeper will be recognized as one big memory card (linear addressing) allowing up to **16 Meg** of total memory. It supports most Apple® IIgs® memory expansion cards and allows you to divide the memory for use as a ROM Disk, RAM Disk, and system memory in 1K increments.

**V**ETERAN and novice computer card installers alike will breeze through the installation of the card. You don't even have to insert a disk to configure the RamKeeper's setup .the RamKeeper has its own built-in software (firmware) contained in a ROM (EPROM) of its own. The step-by-step instructions will ease you through installing the cards and configuring the memory.

**E**XTRAS: With your RamKeeper, we've included AW 2 Expander™, Applied Engineering's popular enhancement package. The enhancements to AppleWorks™ include increased number of word processing lines and data base records, multiple disk save capability, on-screen time display and much more! The Expander disk also includes the *Æ*Cache™ program which greatly increases disk access speed for your Apple 3.5 Drives. With these great enhancement features, your RamKeeper rises from the ranks of the incredible to the level of the invaluable.



**NOTES** and Warnings throughout the manual will help you to better understand what you're dealing with. They appear as shown in the example below:

\* *Note:* This indicates a special note or warning. Pay close attention to these entries.

**SOLVE** most minor problems with the Trouble Shooting guide located toward the back of the manual

**HERE'S** your chance to put more juice in your Apple. So turn the page and get started. You've got a lot of memory waiting.

# CHAPTER ONE

---

## *Getting Started*

### **Required**

To use RamKeeper, you must have the following:

- ◇ An Apple IIGS
- \* *Note:* Due to physical constraints, a //e upgraded to a IIGS will not support a RamKeeper.
- ◇ At least one memory card. This memory card can be any one of the following:
  - GS-RAM™ (any rev)
  - GS-RAM Plus (any rev)
  - GS-RAM 2 Meg Expander (any rev)
  - Apple IIGS Memory Expansion™
  - OctoRam™
  - RamPak 4G™
  - RamStackPlus™
  - OnBoard™
- \* *Note:* This list was complete at time of publication. Other IIGS RAM cards may work.

### **Recommended**

Even though RamKeeper uses a switching power supply which keeps its operation cool, several powerful cards in your closed computer generate lots of heat. We recommend the IIGS System Saver from Kensington to keep it running cool.

### **Possible Combinations**

RamKeeper allows you to attach memory cards in many different combinations. Some cards must be attached to the front side of the card. Others must be connected to the back. Still others require the use of the optional SlotMover. Determine if you'll be connecting one or two cards, then find your card(s) in the lists below to determine where to connect it (them).

## One Memory Card on RamKeeper

If you want to attach only one card to the RamKeeper, you will, in most cases, want to plug it into the Back Pocket™. This keeps slot 7 clear.

Use the drawing below to help you determine if you can use the Back Pocket for your card or, if not, which connector you'll need to connect it to the front side of the RamKeeper.

### Slot Mover

All GS-RAM cards  
(including 2 Meg Expander)  
Apple IIGS Memory Expansion Card  
RamPak 4GS  
Card  
RamStackPlus  
OnBoard  
OctoRam

### Front Connector

All GS-RAM cards  
(except 2 Meg Expander)

### RamKeeper

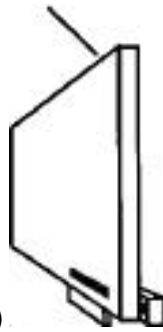

### Back Pocket

GS-RAM REV C or later  
GS-RAM Plus REV 0 or later  
GS-RAM 2 Meg Expander  
Apple IIGS Memory Expansion  
RamPak 4GS  
RamStackPlus  
OnBoard

\* Due to its large size,  
OctoRam will not fit on the  
back side of RamKeeper

## Single Card Options

- \* **GS-RAM Note:** GS-RAM REV A and GS-RAM Plus REV A cards require the optional SlotMover to keep slot 7 clear. The REV A cards have the silver pins extending from the black connector on the back side of the card just above the edge connector. If placed in the back pocket, these pins keep the card from fitting properly between the RamKeeper and the right side of the IIGS case. Although it is possible to cram the REV As into the Back Pocket, the pins may hit the metal of the computer case and short out the board(s).
- \* **OctoRam Note:** Due to its large size, OctoRam will not fit on the back side of RamKeeper. If you're connecting an OctoRam to the front side of the card, the last two memory rows must be empty. So, if you're using 256K chips, you can only have 1.5 Meg of the card filled, If you're using 1 Meg chips, you can have only 6 Meg filled.

## Two Memory Cards on RamKeeper

When using two cards with the RamKeeper, the card on the back side of RamKeeper must have memory in increments of 512K. So, you can use cards with 512K, 1 Meg, 1.5 Meg (i.e. GS-RAM), 2 Meg, 3 Meg, etc.

The drawings below illustrate the combinations we have tested and know will work. While other combinations may work, the combinations below are the ones we support.

### Slot Mover

All GS-RAM cards  
(including 2 Meg Expander)

### Front Connector

All GS-RAM cards  
(except 2 Meg Expander)

### RamKeeper

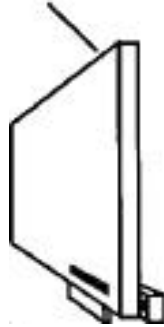

### Back Pocket (in 512K increments)

GS-RAM REV C or later  
GS-RAM Plus REV 0 or later  
GS-RAM 2 Meg Expander  
Apple IIGS Memory Expansion Card  
RamPak 4GS  
RamStackPlus  
OnBoard

\* Due to its large size,  
OctoRam will not fit on the  
back side of RamKeeper

### Slot Mover

Apple 256K - 1 Meg  
RamStackPlus 256K - 1 Meg  
OnBoard 1 - 4 Meg  
OctoRam 256K - 1 Meg (256K chips)

### RamKeeper

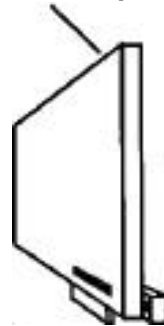

### Back Pocket

Apple 1 Meg  
RamStackPlus 1 Meg  
On Board 4 Meg

### Slot Mover

RamPak 4GS 512K - 1 Meg  
OctoRam 1 Meg - 4 Meg (1 Meg chips)

### RamKeeper

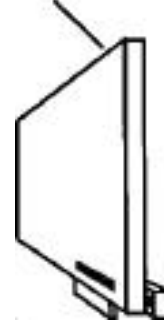

### Back Pocket

RamPak 4GS 4 Meg

## Installation

Use the pictures below to locate the parts referred to in the installation section.

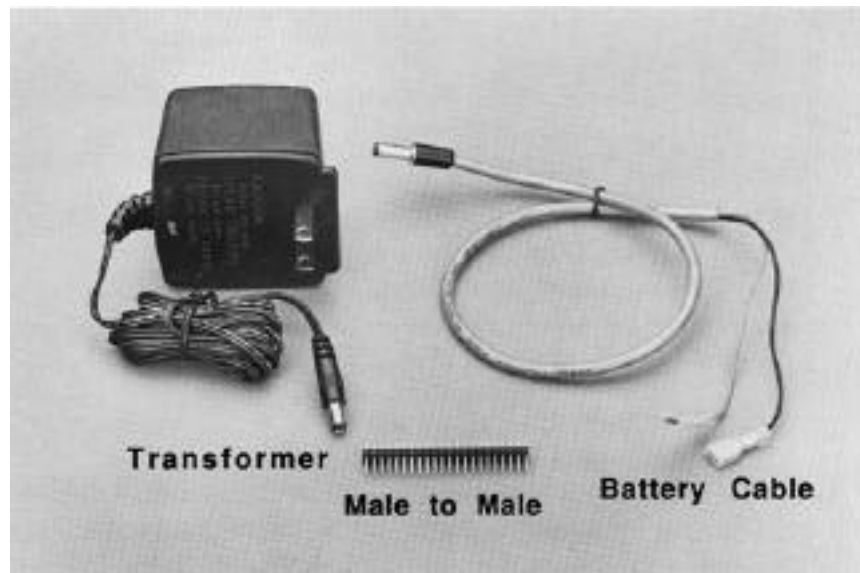
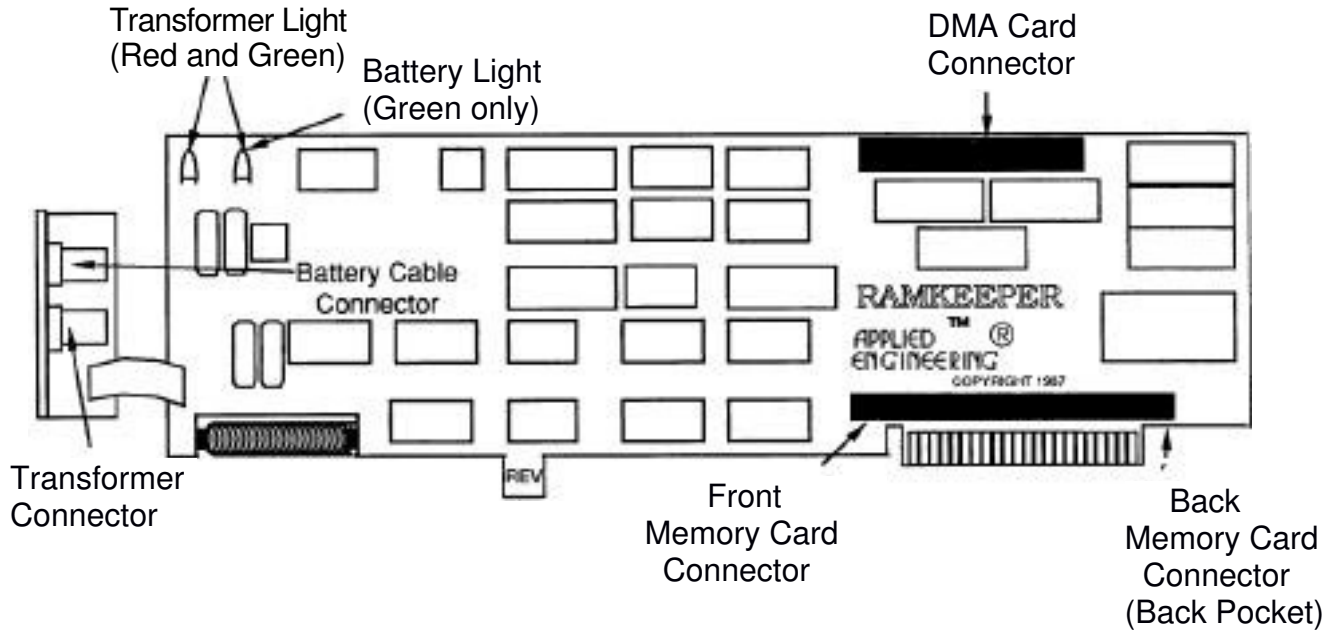

**Cables and Connectors**

To install the RamKeeper, you'll need a Phillips screwdriver. Once you have it, follow the steps below:

- 1.) **TURN OFF THE APPLE'S POWER SWITCH.** Never install or remove a card while the computer is on. However, you need to leave the computer plugged in throughout the installation to allow the power supply to discharge static electricity from your body.
- 2.) **Remove the cover from the Apple.** Press in the two latches in the rear of the case with your forefingers while using the heel of your hand to pull the lid up and towards you. (See below.)
- 3.) Touch the power supply to remove any static electricity from your body. Do not skip this step! A static shock can damage the chips on your boards and/or the chips on your computers motherboard.



**Remove the IIGS cover**

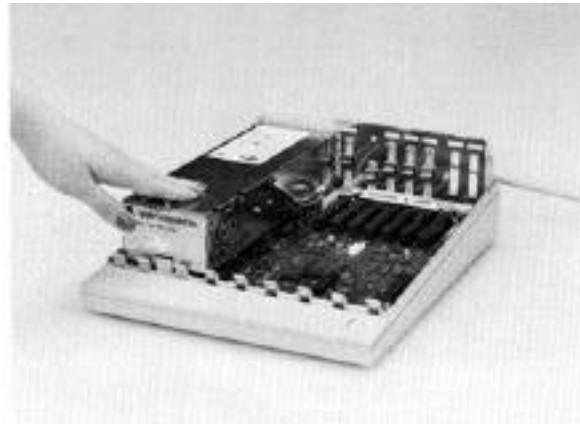

**Touch the power supply case**

- 4.) **You may want to remove any cards in slots 6 and 7 to give yourself a little more room to operate.** If you do remove any cards, follow the instructions that came with those cards for removing and reinserting. Applied Engineering will not be responsible for any damage to your other cards.

- 5.) **If the plastic plate is still covering the far right opening in the backplane, remove it.** This cover must be removed whether or not you plan to connect the Transformer or battery.

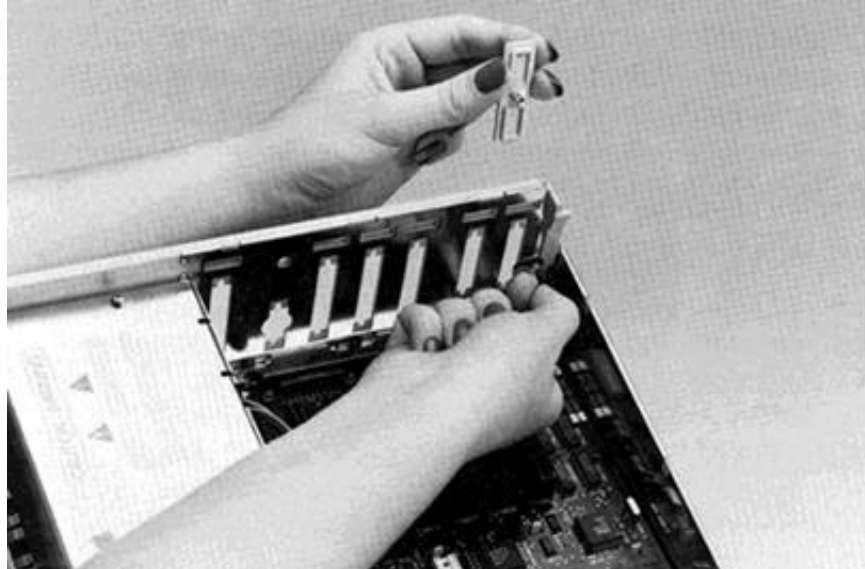

**Remove the plastic plate**

- 6.) **Gently bend down the ferrite beads located toward the back right corner of the motherboard.** These beads may keep the RamKeeper from seating properly.

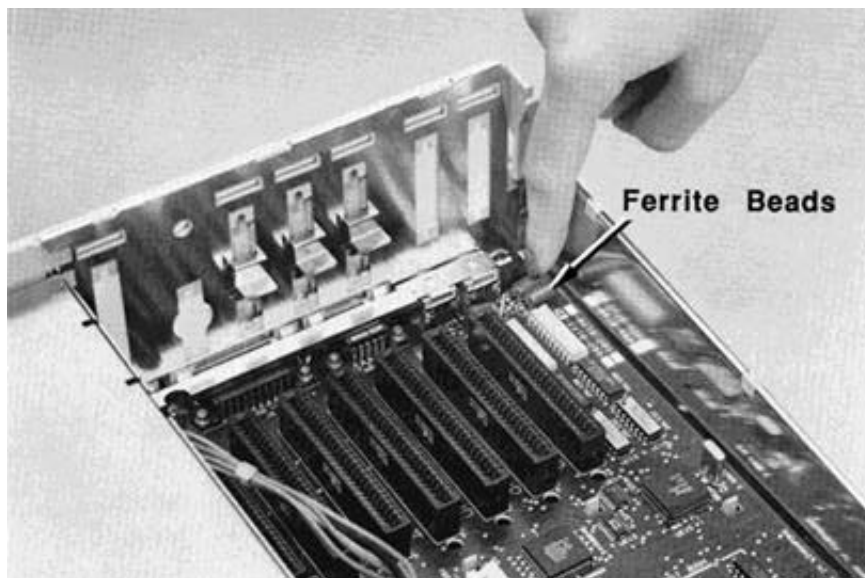

**Bend down the ferrite beads**

- 7.) **Both of the wires that lead to the GellCell should be disconnected.** If they aren't, disconnect them now.

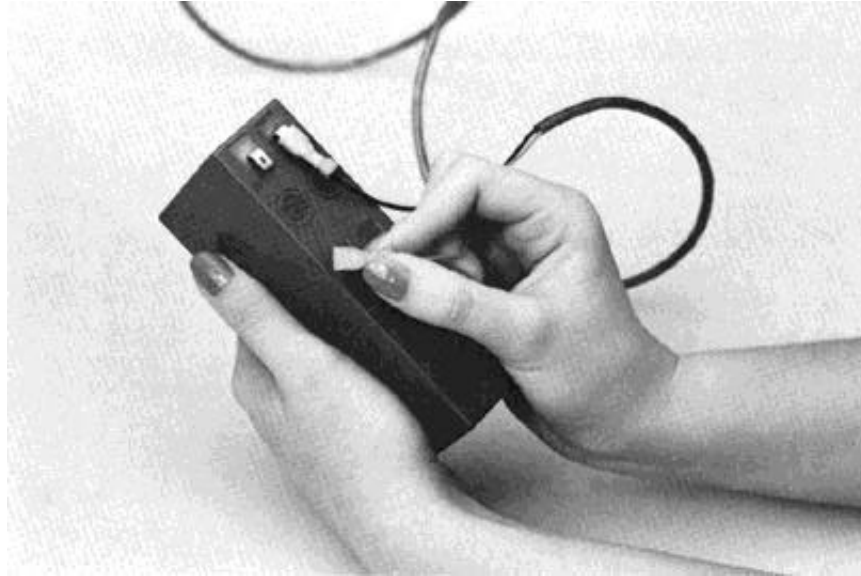

**Disconnect the battery wires**

- 8.) **Remove the RamKeeper from its anti-static bag.** Hold the card by its edges, like a photograph.
- 9.) **Connect your card or cards** according to the instructions below. Refer to the illustration below for the proper connector and placement of your card(s).

**Slot Mover**

- All GS-RAM cards (including 2 Meg Expander)
- Apple II GS Memory Expansion Card
- RamPak 4GS
- RamStackPlus
- OnBoard
- OctoRam

**Front Connector**

- All GS-RAM cards (except 2 Meg Expander)

**RamKeeper**

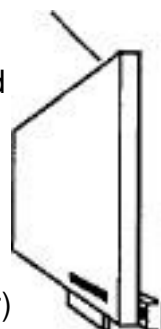

**Back Pocket**

- GS-RAM REV C or later
- GS-RAM Plus REV D or later
- GS-RAM 2 Meg Expander
- Apple II GS Memory Expansion Card
- RamPak 4GS
- RamStackPlus
- On Board

\* Due to its large size, OctoRam will not fit on the back side of RamKeeper

**RamKeeper Connections**



- \* *Note:* If you're connecting only one card and it will work in the back pocket, you should install it there as this is the easiest connection to make. (Skip to step 10.)

### **Connecting GS-RAM Cards to the RamKeeper's Front**

- \* *Note:* If you have a SlotMover, skip to the next section.

To connect directly to the front of the RamKeeper, all GS-RAM cards (except the GS-RAM REV A and the CS-RAM-Plus REV A) require the male to male connector. (If you're using a GS-RAM REV A or a GS-RAM Plus REV A, skip to step "C".)

- A) First, notice the white pegs in two holes of the RamKeeper.

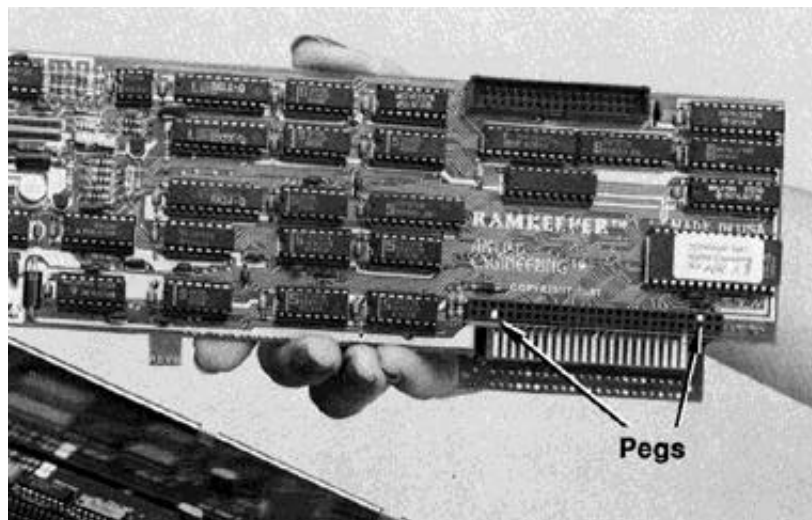

**Note pegs in front connector**

- B) The male to male adaptor will fit in the holes between these two pegs. Don't force the adaptor into the holes; simply set the long pins into the holes, as shown.

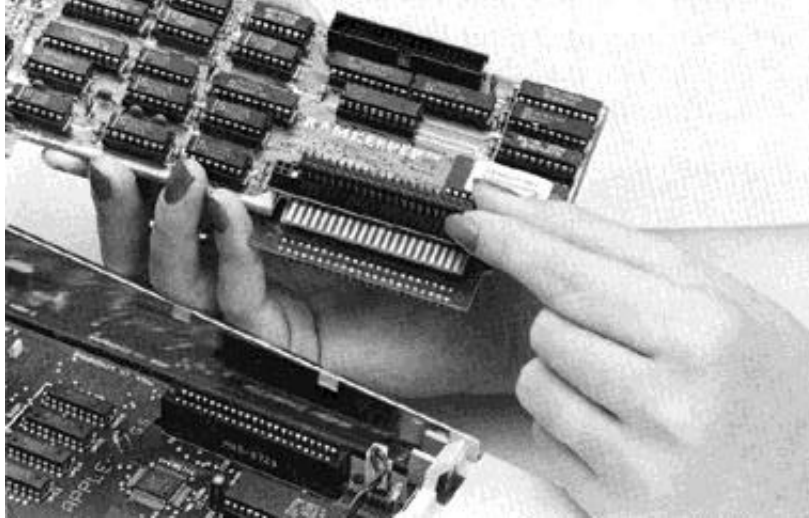

### **Set adaptor in holes**

- C) Align the connector on the back of the GS-RAM card with the exposed smaller pins of the male to male connector. (GS-RAM REV A and GS-RAM Plus REV A users, align the pins on the back of the GS-RAM with the holes in the RamKeeper connector.)

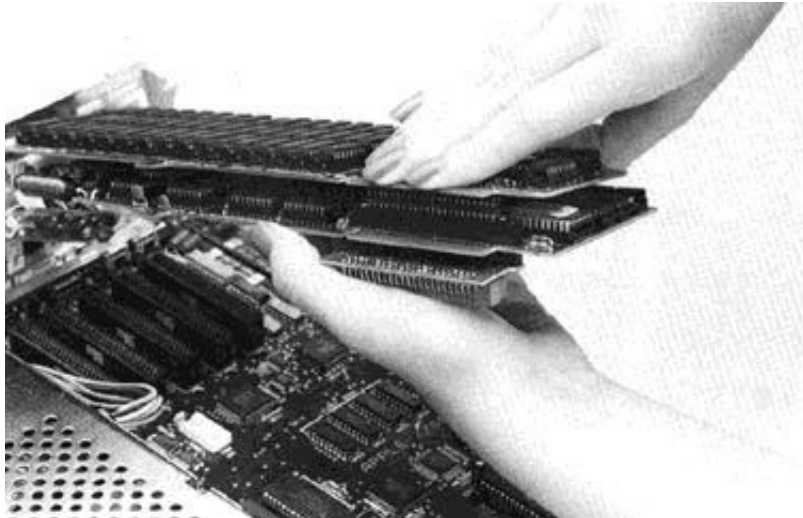

### **Align Gs-RAM connector with pins**

- \* *Note:* Take your time in aligning the pins and connecting the cards. If they are not aligned properly, you may bend the pins.
- D) Holding the card as shown above, alternate between pressing down firmly on the connectors and the tops of the cards in a slow, rocking motion. The cards and the adaptor will gradually mesh together.

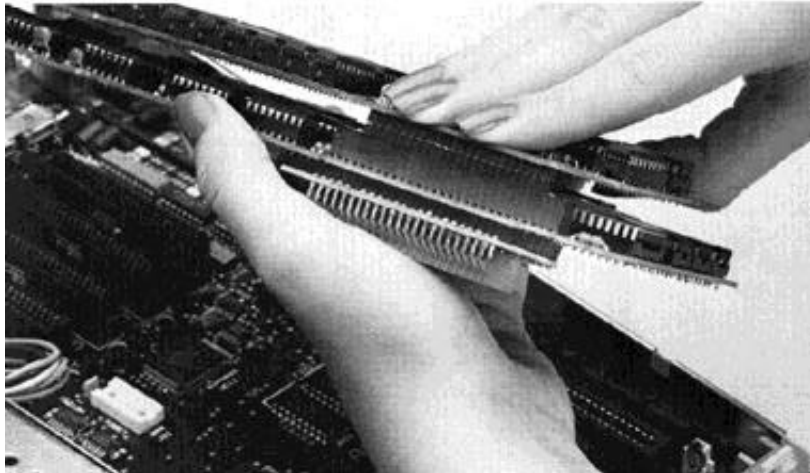

**Push until all pins are completely seated**

## **Attaching the Optional SlotMover**

The SlotMover is an extension board that shifts the expansion board on the front side of the RamKeeper so that it won't block slot 7. (Slot 7 is commonly used for hard drive controller cards.)

Its new position is between slots 4 and 5. Because 4 is the mouse port and 5 is the disk drive port, you'll probably never want to put a card in either.

- A) First, lay the RamKeeper face up on the table.
- B) Notice the white pegs in two holes of the RamKeeper's front connector. (See picture on page 8.)
- C) Push the SlotMover pins into the holes between these two pegs.

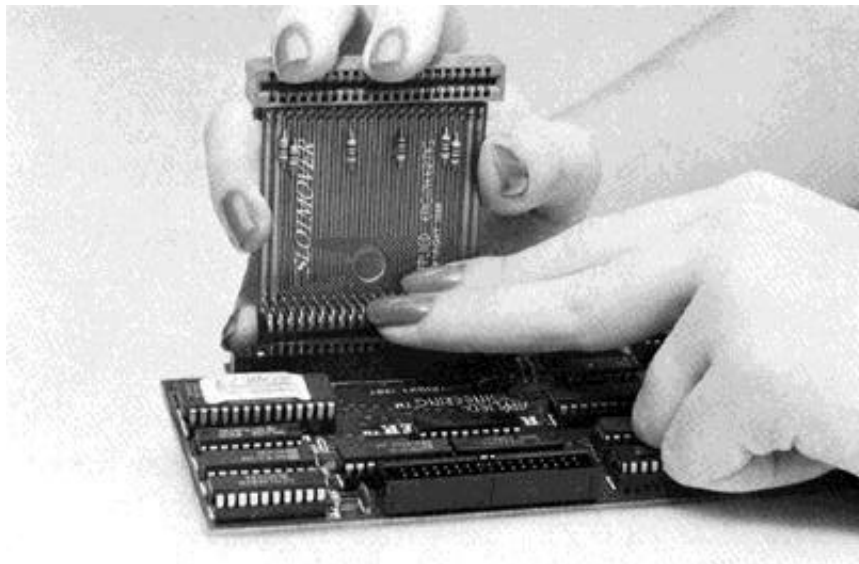

### **Insert SlotMover into connector**

- D) Push until SlotMover pins are completely seated

Don't insert a card in the SlotMover until you have plugged RamKeeper into the Memory Expansion Slot.

## Connecting Cards to the Back of RamKeeper

To connect a card to the back of RamKeeper, you'll simply insert the card's edge connector into the Back Pocket's slot after you have inserted the RamKeeper into the Memory Expansion Slot.

\* **Warning!** Make sure all power is off before continuing. Both LED's should be off and. power to the computer should still be off.

10.) **Insert the RamKeeper into the Memory Expansion Slot.** Align the RamKeeper's edge connector with the Memory Expansion Slot then use the heel of one hand to push the card down into the slot and seat it firmly.

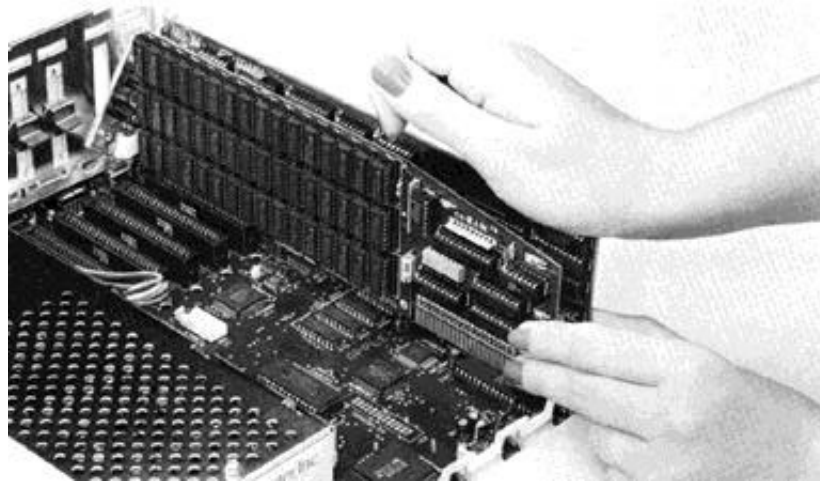

**Insert RamKeeper into Memory Expansion Slot**

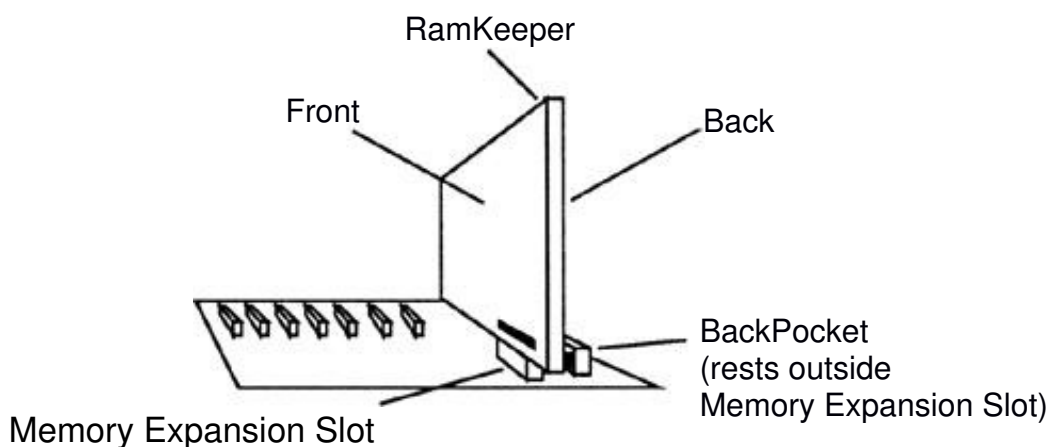

- 11.) **Install the connector plate using the screws provided.** Line up the holes of the connector plate with the notches at the top and bottom of the opening in the backplane. Insert and tighten the screws using the hex wrench provided.

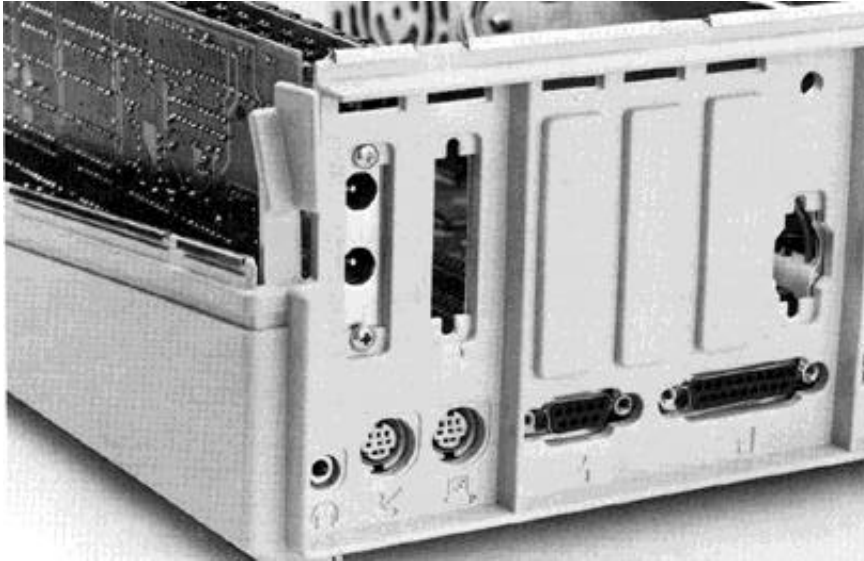

### **Attach connector plate to backplane**

- 12.) **If you're installing a card into the Back Pocket, do so now** by lining up the fingers of the memory card's edge connector with the Back Pocket's slot and using the heel of one hand to seat the card firmly.
- 13.) **Insert the insulator sheet** included with RamKeeper between the back of the RamKeeper and the right side of the computer case. Slide the insulator as far toward the keyboard end as possible.  
Even if you aren't using the Back Pocket or the Flex Connector, insert the insulator. This way, you'll know where it is when you expand in the future.

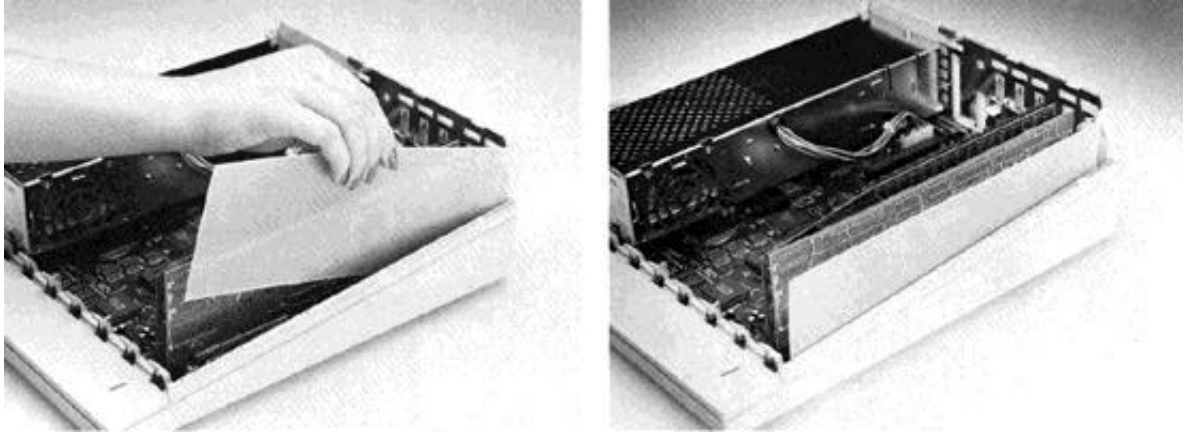

### Insert insulator

- \* *Warning!* Before connecting the power, you must have the insulator installed.
- 14.) **Plug the Transformer's connector into the bottom socket** of the connector plate you have installed in the backplane (see picture below).
- 15.) **Plug the Gel/Cell's connector into the top socket.**

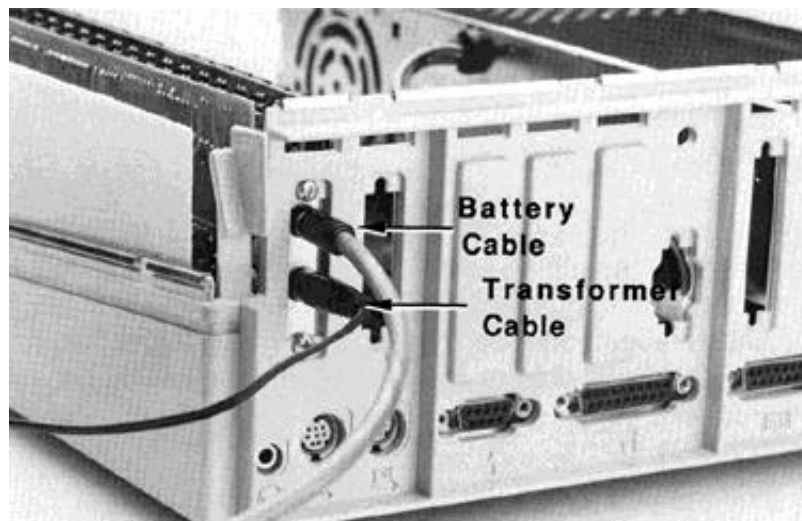

**Plug the transformer and battery into the sockets**

- 16.) **Reconnect the battery cables to the GellCell's connectors.** The green LED light on the RamKeeper should come on. This indicates that your battery is working. If it doesn't come on immediately, it is because it needs to be refreshed after its journey from our hands to yours. Continue with the installation and the Transformer will trickle charge the battery back to its full potential within 24 hours.
  
- 17.) **Plug the transformer into a wall outlet.** This wall outlet should be independent of wall switches and dimmer switches. If you must use a switch controlled outlet, make sure the switch remains on.
  
- 18.) **Check the LED lights** to make sure the transformer is functioning. Both lights should be on. If they are not both on, check the transformer's connections.
  
- 19.) **Replace the Apple's cover.** You may need to guide the insulator inwards as you close the cover.
  
- 20.) **Hardware installation is complete.** Now you'll need to set up your ROM Disk with the firmware.

## **The Double Boot**

When using certain configurations with RamKeeper, your GS will beep twice when you boot it. The first beep is normal power up. The second is RamKeeper installing itself and resetting the computer. Some configurations do not require the double boot.



## What Now?

### Experienced Users:

If you understand the ROM Disk and know what you want from yours, you can set the size and be on your way. To install the `AE RamKeeper Desk Accessory` under ProDOS 16 you will need to copy the `AERAMKEEPER` file (`/AEROM/AERAMKEEPER`) from RamKeeper's self-created ROM Disk (`AEROM`) into the Desk Accessories folder (subdirectory) of your boot disk (`/YOUR . BOOT/SYSTEM /DESK. ACCS`). (ProDOS 8 will automatically load the `AE RamKeeper Desk Accessory`.)

\* *Note:* You'll need to have Slot 5 set to Smart Port and Startup Slot set to Scan.

Now you can access the Classic Desk Accessories (CDA) menu, select the option, `AE RamKeeper`, and use the `Initialize ROM Disk` option to set the ROM Disk size and be on your way.

When you want to know more about a particular aspect of the card, use this manual as a reference.

### Others:

The next chapter, "RamKeeper Firmware" will tell you what options are available to you and help you set up your memory.

# CHAPTER Two

## *RamKeeper Firmware*

The software needs little or no explanation for basic operation; it's simply simple to use. However, not knowing the full potential of its functions is like owning a James Bond car and not knowing what the buttons do.



To fully understand and take advantage of RamKeeper's features, read through this chapter once and display the menus on your screen as they're being described.

### **About The Firmware**



All of RamKeeper's firmware resides in an EPROM on the RamKeeper card. We have loaded it with features while keeping it easy to use. The RamKeeper utilities include memory tests, an auto startup checksum, a data recovery mechanism, ROM size reallocation (with no loss of data stored in ROM) and more.

This sounds like a lot to control, but if you can use the IIGS Control Panel with no problem, mastering RamKeeper will be a breeze.

### **Loading the Firmware**

Boot up your computer as you normally do. Then access the Classic Desk Accessories menu (CDA) by holding down the Open Apple and Control keys while pressing ESC (- then ).

- \* *Note:* If your computer is giving you a boot error message, don't worry; it is because your startup slot has now been changed. Continue with these instructions.

Use the up and down arrow keys ( ), as instructed at the bottom of the menu, to highlight the Control Panel option. Press "Return."

Highlight the Slots option and press "Return."

Set Slot 5 to Smart Port and Startup Slot to Scan if they are not already set that way. Now reboot your computer.

- \* *Note:* If you don't know how to change the settings in the Control Panel, refer to your *Apple IIGS Owner's Guide* for instructions on using the Control Panel.

When you reboot your computer, RamKeeper creates a 63K ROM Disk containing a file, "AERAMKEEPER." You'll need to copy the file to the DESK.ACCE folder in your SYSTEM folder.

- \* *Note:* This file is used only by ProDOS 16. If you'll be using only ProDOS 8, the AERAMKEEPER desk accessory will be installed automatically--you don't need to copy the file and you can skip to the next section.

If you're using the Finder, the copy process is easy. You'll see the RamKeeper's initial 63K ROM Disk on the Finder:



Double click on this icon and you'll see the file, AERAMKEEPER.

Open (double click) your ProDOS 16 SYSTEM folder.

Locate the DESK.ACCE folder.  
Now click on and drag the AERAMKEEPER file from the ROM Disk to the DESK.ACCE folder.

Repeat these steps to copy this file to any other System disks you may want to boot from.

Reboot your computer.

- \* *Note:* If you prefer not to use the Finder, use your own favorite copy program to transfer the AERAMKEEPER file into the DESK.ACCE folder:

Source: /AEROM/AERAMKEEPER

Destination: /YOUR.BOOT/SYSTEM/DESK.ACCE

The RamKeeper will now automatically install its firmware utilities into the Classic Desk Accessories (CDA) menu every time you boot using a system disk containing the `AERAMKEEPER` file.

- \* *Remember:* To be able to access the AE RamKeeper Desk Accessory, you must copy this file to any boot disk you'll be using. So, if you plan to boot from your ROM Disk and want access to RamKeeper's firmware, you'll need to copy it to the Desk Accessories folder (subdirectory) on your ROM Disk.

Once you have copied the file to your `DESK.ACCS` folder, you can delete the file from `AEROM`.

If you ever lose the system disk(s) that contains this file, you'll need to reinitialize the ROM Disk so that it will create another `AERAMKEEPER` file. Be sure to save your ROM Disk files to floppy disks before reinitializing.

- \* *Note:* For more information about using the Finder, refer to the *Apple IIGS System Disk User's Guide*.

## Accessing the Firmware

Access the Classic Desk Accessories menu by holding down the Open Apple and Control keys while pressing ESC then (⌘-⌥ then ⌘). Pressing these three keys will display a Desk Accessories menu much like the one shown below (appearance may vary according to which Desk Accessories you have loaded).

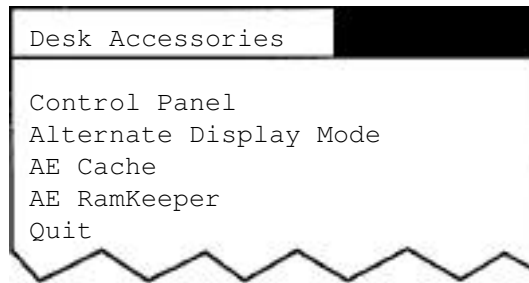

### Classic Desk Accessories Menu

Use the up and down arrow keys (↑ ↓) as instructed at the bottom of the menu screen, to highlight the RamKeeper option. Press Return.'

The RamKeeper main menu will appear as shown below:

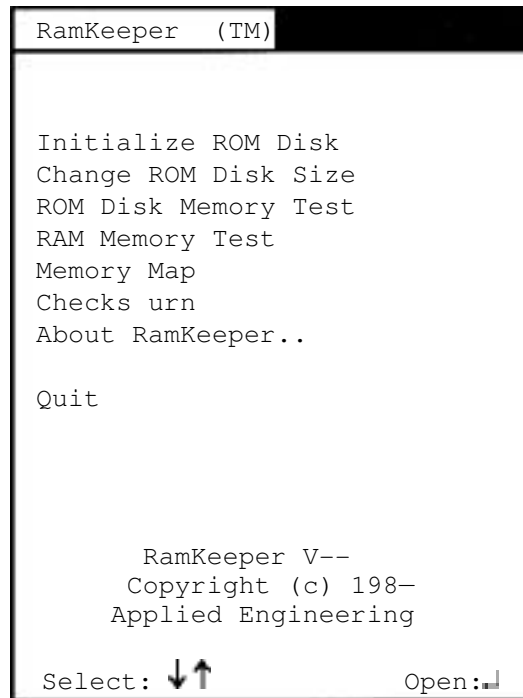

### RamKeeper Main Menu

Again, use the up and down arrow keys to select the option. The different options and their functions are described below.

To set your ROM Disk to the size you want, you'll need to go into the IIGs Classic Desk Accessories menu, select the AE RamKeeper option and set the ROM Disk size using the Initialize ROM Disk option.

## **Initialize ROM Disk**

The only option you can directly alter in this menu is the ROM Disk Size setting.

When you first boot the RamKeeper, it creates a 63K ROM Disk. However, the Memory Allocated For ROM setting will show a 64K ROM Disk. This is because RamKeeper uses 1K of protected memory for itself.

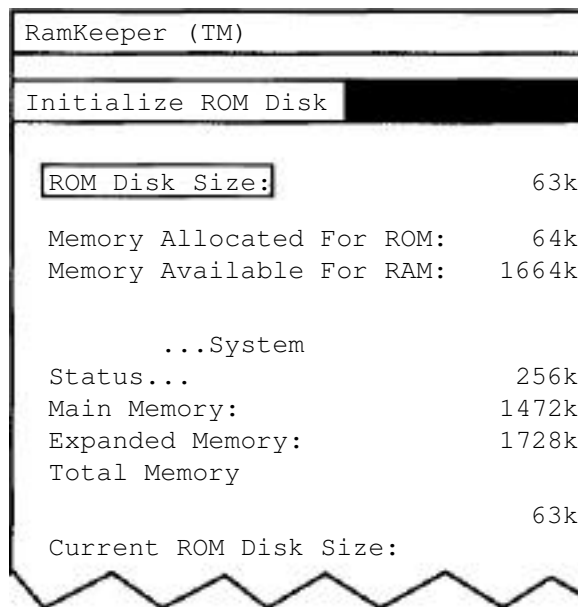

### **Initialize ROM Disk Menu**

Increasing or decreasing the ROM Disk Size setting will also change both the Memory Allocated For ROM and the Memory Available For RAM settings accordingly.

While you can make changes to the ROM Disk Size in 1 K increments, the Memory Allocated For ROM increases in increments of 64K (a ProDOS criteria). So, when you set the ROM Disk size to 64K, you're actually using 65K (1K used for RamKeeper). Since you crossed a 64K boundary, the Memory allocated for ROM jumps up to 128K (2 x 64).

The 63K between your 64K setting and the 96K allocated for ROM is not used. So, once you cross over a 64K boundary like that, you might as well use the maximum memory available within that range. For the example above, you might as well set ROM Disk Size to 127K.

## Setting the ROM Disk Size

To increase or decrease the ROM Disk size by 1K, use the left or right arrow key.



Each time you press the left arrow key, the ROM size will **decrease by 1K**.



Each time you press the right arrow key, the ROM will **increase by 1K**.

To increase or decrease the ROM Disk size in **32K** increments, hold down the open apple key while pressing the left and right arrow keys.



Each time you press the left arrow key with the open apple key held down, the ROM size will **decrease by 32K**.



Each time you press the right arrow key with the open apple key held down, the ROM will **increase by 32K**.



Accepts the current setting.





ESC cancels the operation and returns to the main menu.

When you press  you'll see the following message:

**Warning:**  
You're are about to  
destroy your existing  
ROM Disk and RAM Disk.

Do you really want to do  
this?

Press Return again to initialize a new ROM Disk and  
reboot the system or press  to back out. Pressing   
will return you to the Initialize ROM Disk menu.

## **Change ROM Disk Size**

This menu is identical to the Initialize ROM Disk menu with the addition of the Minimum ROM Disk Size: setting. Within this menu, you can increase and decrease the size of the ROM Disk (using the arrow keys as previously described) without endangering what is currently on the ROM Disk.

The minimum ROM size is calculated by finding the last block of information currently stored in ROM and backing up to that point. The existing files are protected in this way.

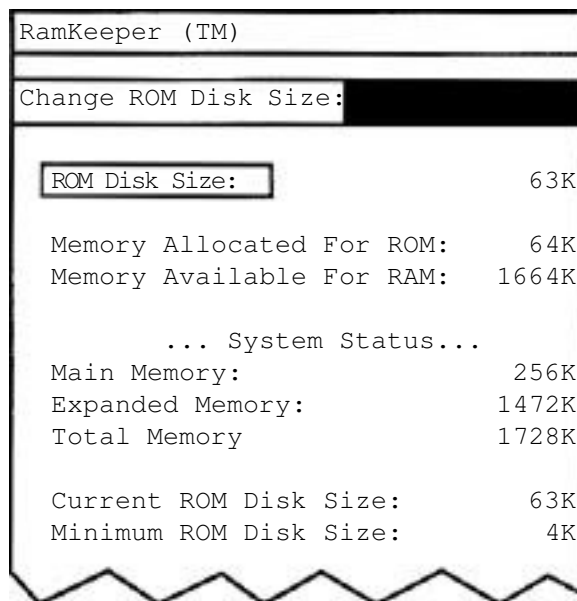

**Change ROM Disk Menu**



As you increase or decrease the ROM Disk Size: setting, the Minimum ROM Disk Size: as well as the Memory Allocated For ROM: and the Memory Available For RAM: settings adjust accordingly.

Select the size ROM Disk you want and press return. (For a discussion of how much memory should be allocated to ROM, see, *Memory Allocation*.) If you have more than 2 Meg of memory installed, see, “*More than 2 Meg*” in the previous section.

- \* *Important:* Resetting the ROM Disk size will, in effect, “cold boot” your computer. So, while files in your ROM Disk will remain untouched, anything you might have stored in your RAM Disk will be erased. If you didn’t save your RAM

Disk contents and you want to, press  to back out of this menu and save the RAM contents to disk before returning to this menu.

## More than 2 Meg

Those using more than 2 Meg of memory may come across an easily surmountable obstacle. ProDOS allows bit map blocks in increments of 2,048K (4,096 blocks). If you find that you cannot increase your ROM Disk past a certain size, it has probably stopped at a multiple of 2,048K. If you want to go above that, you will need to reinitialize your ROM Disk for more than that multiple of 2,048. For instance, if you set the ROM Disk size to 2,049, then initialize, you can change your ROM Disk size to any setting from 4K to 4,096K. If you set your ROM Disk to 4,097K, you’ll have a range from 4K to 6,144.

### ROM Disk Memory Test

Use the ROM Disk Memory Test to test the memory used by the ROM Disk without destroying the contents of that memory.

This a quick test that will run as soon as you select the option from the RamKeeper main menu.

While the test is running, bar graphs will show you the test’s rapid progress through two passes.

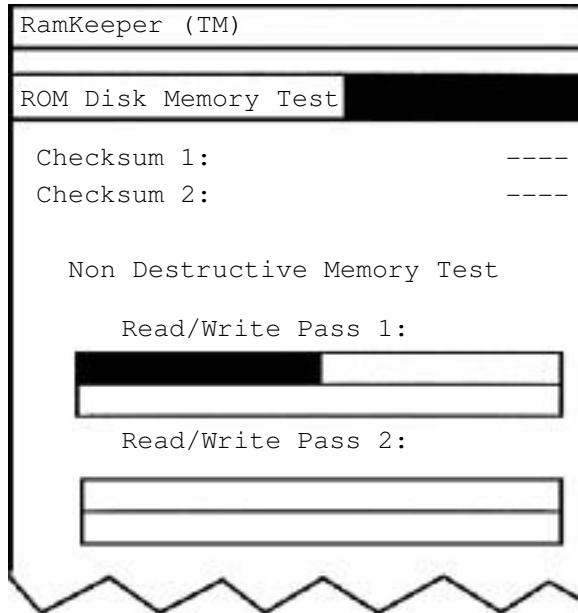

### **ROM Disk Memory Test Menu**

- \* **Warning:** Do not reset while this test is running or you will destroy your ROM Disk.

When the test is complete, you will be told either,

**... Card Passed ...**

or

**... Card Failed ...**

If the card fails this test then the user should remove the memory card(s) from the RamKeeper and test them individually using the software supplied with the memory card(s). Testing the cards individually will save you the time and trouble of trying to repair the wrong card.

### **RAM Memory Test**

This test is much like the ROM Disk Memory Test but will test the memory allocated as RAM without destroying its contents.

This test is also run as soon as you select it from the RamKeeper main menu.

The bottom of the screen displays graphics (plus signs turning into minus signs then back again) to let you know that the test is running.

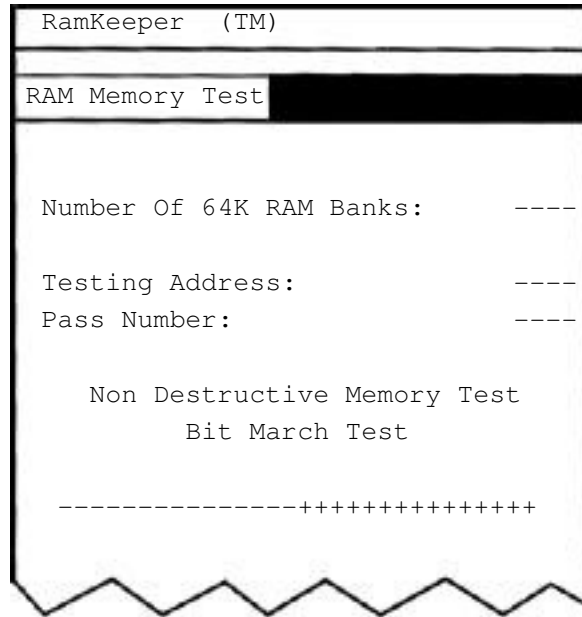

### RAM Memory Test Menu

This test will continue until you abort by pressing   
You can quit this test at any time.

### Memory Map

The Memory Map option gives you a graphic display of how much memory is allocated for RAM and how much for ROM.

The open-apple characters represent RAM while the closed-apples represent ROM. Missing characters mean that there is no memory at the indicated bank.

The bottom of the chart tells lists the kind of card(s) (“AE” or “Other”) and tells you the memory configuration of each.

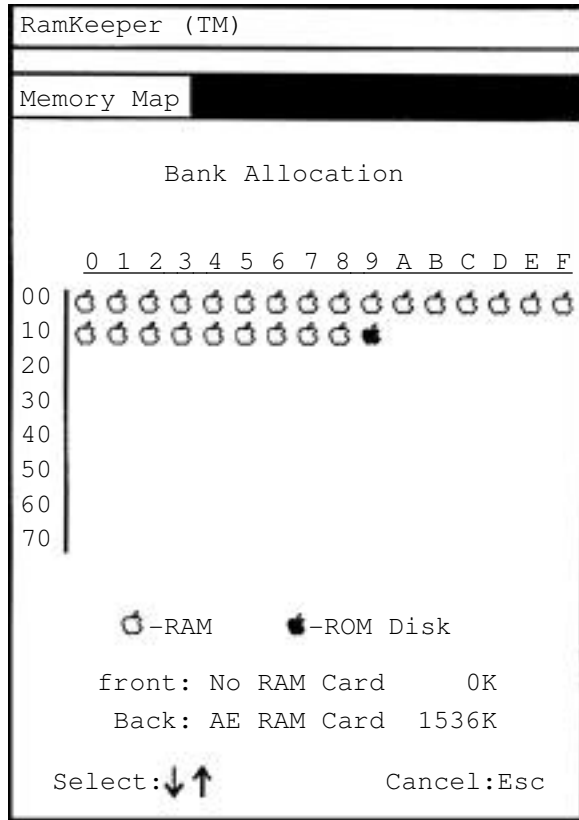

### Memory Map Menu

## Checksum

Selecting this option from the main menu gives you a 16 bit EOR checksum. This checksum will appear next to the Computed Checksum.

The Current Checksum is only reported if the Continuous Checksum is on (Yes). If the Continuous Checksum is on, then it should be equal to the Current Checksum.

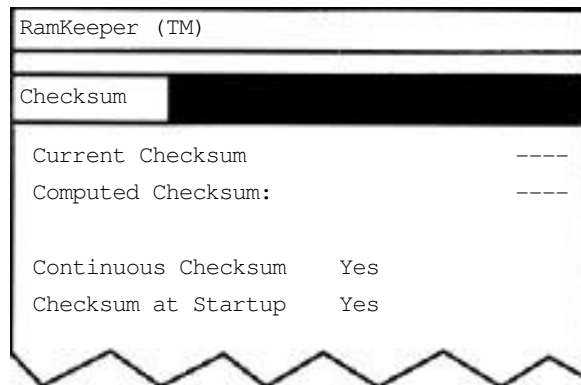

### Checksum Menu

Use the up and down arrow keys to select either the `Continuous Checksum` option or the `Checksum At Startup` option. When either one is highlighted, use the left and right arrow keys to toggle between `Yes` and `No`.

`Continuous Checksum Yes` means that every time a block of memory is written to in the ROM Disk, the EOR checksum is updated. The only disadvantage to this is that you sacrifice some ROM Disk speed for write operations.

The `Checksum At Startup` works in conjunction with the `Continuous Checksum` feature; when you select `Yes` for `Checksum At Startup` then `Continuous Checksum` is also set to `Yes`.

## **About RamKeeper...**

This screen gives credit to the masterminds behind the RamKeeper. It also lists Applied Engineering's Address and phone numbers for Sales and Technical Support.

## **Quit**

Selecting the `Quit` option puts you back into the `Classic Desk Accessories` menu.

## CHAPTER THREE

### *Using the ROM Disk*

After you've initialized and allocated memory to the ROM Disk you can copy your favorite (or most used) non-copy protected ProDOS programs to it and set it up to your hard disk.

You can name the file any name allowed by ProDOS.

#### **Copying Files to the ROM Disk**

There's nothing special about copying files to the ROM Disk. Copy to it just as you copy to floppy disk or hard disks.

If you're using the IIGS Finder™ as your program selector, the ROM drive will appear as a RAM card icon like RAM Disks do.



You can copy to the ROM Disk on the Finder by clicking on the program icon then dragging it to the ROM Disk icon.

You may also use system utilities or many other copy programs to copy files to your ROM Disk (AEROM).

#### **Location of the ROM Disk**

The location of the ROM Disk depends on several things--how your Control Panel is configured, how many other drives are connected, and where the drives are connected.

Use the diagrams below to help you understand where your ROM Disk will be placed.

ProDOS currently allows a total of six drive devices to function at one time. The Smart Port, where your ROM Disk resides, can control up to four of the 6 total drives. You can have four 3.5" drives daisy-chained to the Smart Port or you can have a ROM Disk, a RAM Disk, and two 3.5 drives. The Smart Port drives are controlled separately from drives connected to a disk drive controller in slot 6 and separately from a hard disk in 7.

The Smart Port will access the drives in the order:

Slot 5 Drive 1 (boot drive set up in Control Panel)  
Slot 5 Drive 2  
Slot 2 Drive 1  
Slot 2 Drive 2.

While there are no drives actually connected to slot 2, this is the slot that the Smart Port allocates to the 3rd and 4th drives in the Smart Port drive chain. These are the only slots that will be used by the Smart Port to control disk drives. For additional information about the Smart Port, consult your *Apple IIGS User's Guide*.

## **Slot 2 Consideration**

Slot 2 is commonly used for modems. Since the modem doesn't emulate a block device (disk drive), if you have a modem in slot 2 (a DataLink for example) and slot 2 is set to "Your Card" in the Control Panel, the Smart Port can still use Slot 2 for disk drive allocation. If a memory card that emulates a disk drive is in slot 2 (e.g. RamFactor), then that card will override the Smart Port's 3rd and 4th drives.

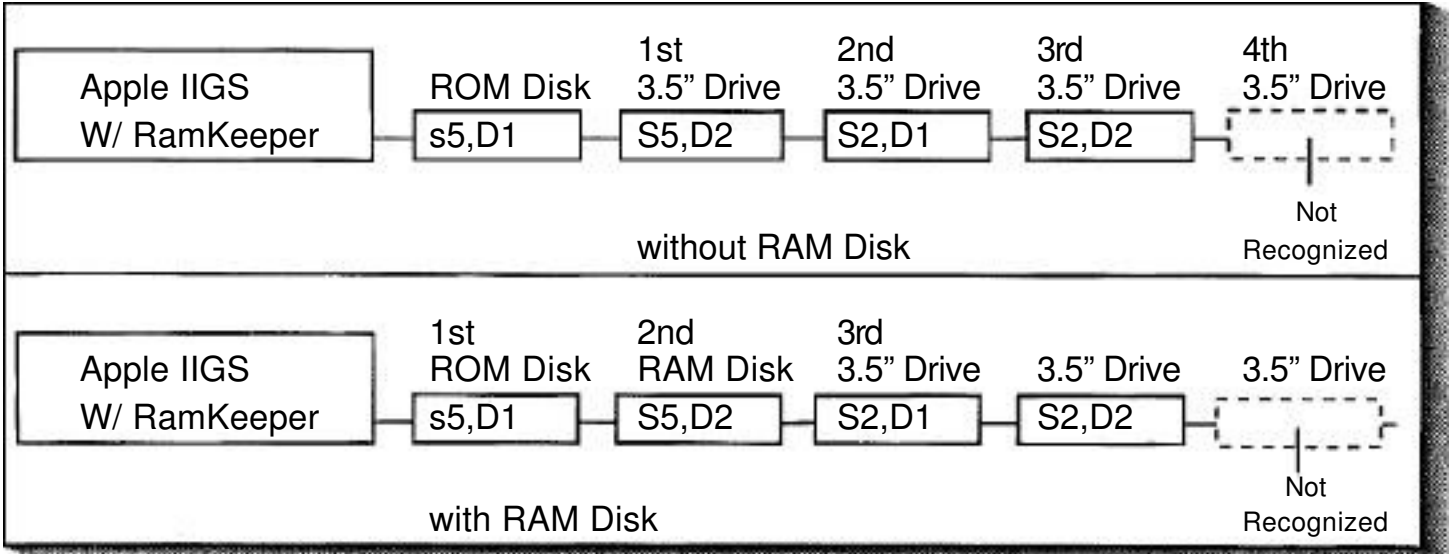

## ROM Disk as Boot Device

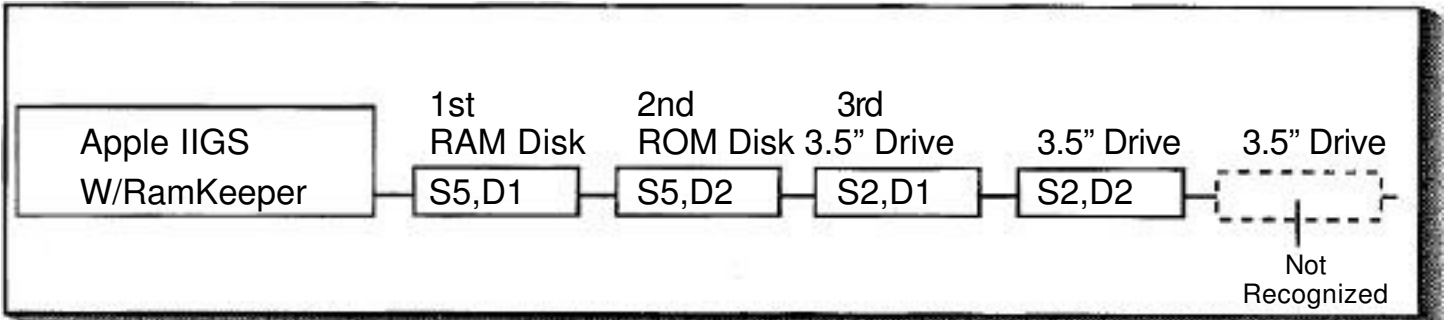

## RAM Disk as Boot Device

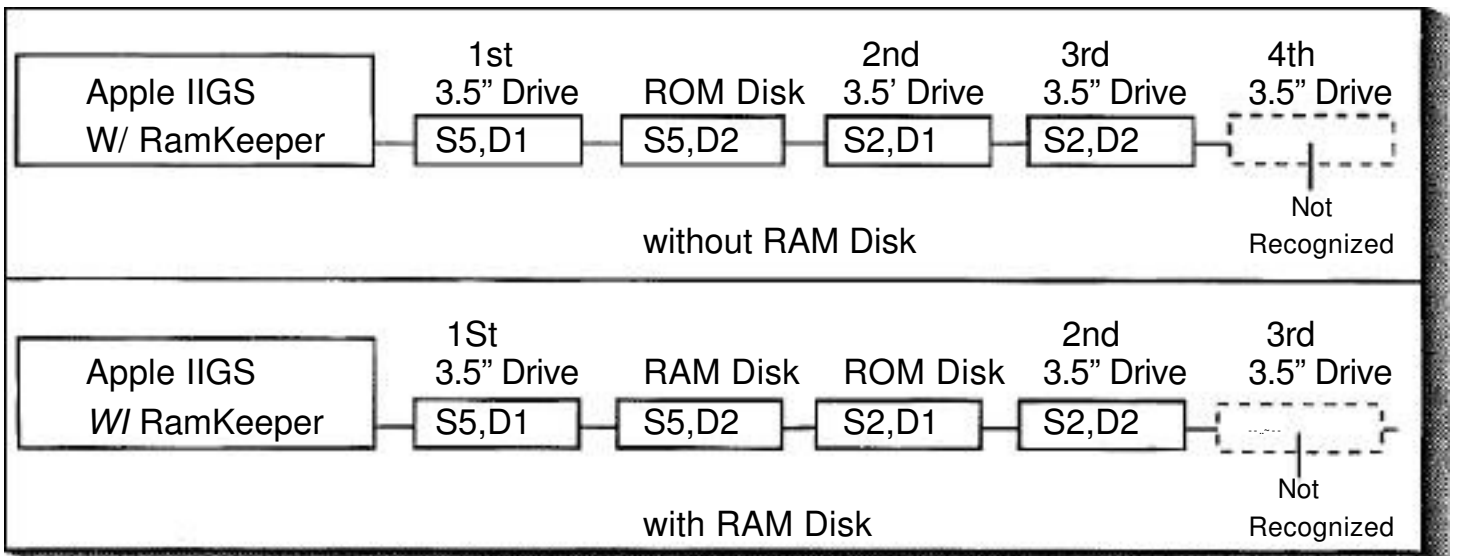



## Floppy Drive as Boot Device



## ROM Drive as the Boot Device

To boot your computer with the ROM Disk:

- 1.) You should already have your ROM Disk set to the size you want.
- 2.) Copy the system files needed to boot the operating system you want to use.
  - \* *Important!* When copying the boot files with the Finder, you'll need to open the disk icon, use the Select All option, then drag all the files from the boot disk to the ROM disk. Simply dragging the System Disk icon to the AEROM will put the boot files in a folder and the computer will give you an "Unable to load ProDOS" error.
  - ◇ If you plan to run only one application from your ROM Disk, you could simply copy the application's boot disk to the ROM Disk (the application must not be copy protected). Then copy the other program files to the ROM Disk.
  - ◇ If you want to use the Finder, copy the files necessary to run the Finder from the Apple IIGS System Disk. The IIGS System Utilities Manual is a great reference source for setup information.
  - \* *Remember:* If you want to access RamKeeper's firmware in ProDOS 16, you'll need to copy the `AERAMKEEPER` file to the Desk Accessories folder in the System folder.
- 3.) Set your ROM Disk as your `Startup Slot`.
  - a) Enter the Classic Desk Accessories menu.
  - b) Select the Control Panel option.
  - c) Choose the option, `Slots`.
  - d) Select `Startup Slot`.
  - e) Use the left or right arrow to select ROM Disk.
  - f) Press 
- 4.) Reboot the GS.

Hold down the  and  keys then press the reset button. This is almost the same as turning your computer off and back on but it doesn't reset the RAM Disk and it saves a lot of wear and tear on the switch.
- 5.) The computer should flow boot from AEROM.

# CHAPTER FOUR

## *The RamKeeper Power*

RamKeeper can get its power from three sources: the wall transformer, the Gel/Cell battery, or the IIGS power supply.

The wall transformer is the primary power source. In the case of a power failure, however, the RamKeeper will get its energy from the Gel/Cell battery until the power failure is over. One battery pack will supply the RamKeeper with power for about 6 hours. This length will of course vary according to the number of RAM cards connected to the RamKeeper and their individual consumption.

If there is no power coming from either the wall transformer or the battery, RamKeeper will get its power from the IIGS (when the IIGS is turned on). This means you will lose all contents of AEROM when you power down.

Two L.E.D.s on the left edge of the RamKeeper indicate the power status of the card.

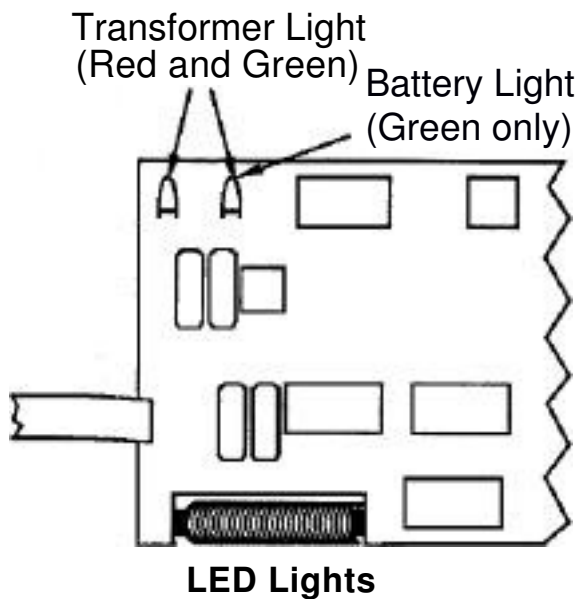

**If only the green light is on** (the one farthest from the edge of the card), it is indicating that the battery is fully charged (above 8.6 volts). When the card is getting power from the battery only, this light will stay on for a very short time. However, the battery will continue to backup the RamKeeper for several hours. (See the chart below.)

As soon as power is restored to the Transformer, it begins charging the battery again and the green light will come on.

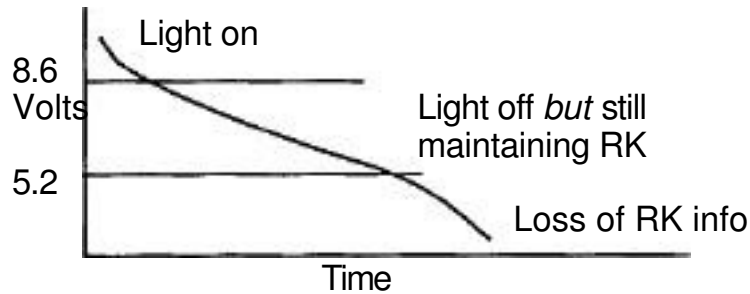

**Time/Voltage chart**

**When both the red and green lights are on** the RamKeeper is being powered by the wall transformer and the battery is being either charged, maintained or is not connected.

**If only the red light is on** the battery is either dead or not connected properly.

## **Battery**

The battery is a sealed Gel/Cell rechargeable battery rated at 8 volts and 3.0 AMP. HR. The capacity of the battery can be increased by adding cells in parallel for longer battery backup time.

Additional batteries are available from Applied Engineering. Each battery carries a one year warranty but with normal use, these batteries should Last about 5 years.

## **Transformer**

The wall Transformer is an unregulated 9.5VDC at 1A supply with a coaxial round connector on one end that plugs into the RamKeeper. The connectors outside contact is positive and the internal contact is ground.

\* **Warning:** Do not use other transformers. The wrong transformer could seriously damage your RamKeeper.

# CHAPTER FIVE

## *A Brief RAM/ROM Tutorial*

### **ROM is...**

**ROM** is an acronym for Read Only Memory. Since a battery backed RAM Disk can be not only read from but also written to, ROM Disk is a misleading name for a battery backed RAM Disk. The reason we call it this is because we used the GSs ROM Disk drivers to support the battery backed RAM Disk. You see, the GS has built-in ROM Disk drivers intended to support ROM chips loaded with programs. For example, you might attach a card to the memory expansion card that has AppleWorks loaded into an EPROM. The AppleWorks program could be loaded from the EPROM at a super high rate of speed. However, the EPROM would be Read only Memory, and no files could be saved to it nor could the program be altered in any way. On the other hand, the RamKeeper not only lets you load programs extremely quickly but also lets you choose the programs you want loaded as well as save files to it. Since ROM Disk is the name that the GS supports, that is what we we call the battery backed portion of memory that RamKeeper keeps alive.

The IIGS has a built-in ROM chip. This is a 128K chip containing information about what the computer should do when it is turned on. The ROM chip also includes Applesoft Basic and the Control Panel program. This chip was programmed by Apple when the computer was manufactured and can't be altered; the 128K memory is not memory you can use for storing data.

### **RAM is...**

**RAM** is an acronym for Random Access Memory. This is the memory that can be both read from and written to -- the addressable (user useable) memory. GS memory expansion cards use RAM chips and can range in capacity from 256K to 8 Meg. (8 Meg is the maximum amount of RAM allowed by the IIGS.)

Many programs automatically look for and use available RAM (system RAM) to give them more room to operate (e.g. desktop space). Many programs load themselves into the available RAM at startup. This greatly increases their performance speed because it reduces or eliminates the need to access the relatively slow mechanical floppy drives.

You have probably already experienced the thrill of loading your favorite (or most used) programs into a volatile RAM Disk and then seeing those programs run faster than they ever could from a floppy disk. You could access these programs from RAM all day. But flipping the power switch or a power outage is like a lobotomy to a RAM Disk.

Now you can know the joy of turning on your computer and having those programs that you previously loaded into RAM appear on your screen instantly. No more setting up a RAM Disk and loading the program every time you turn on your computer.

# CHAPTER Six

---

---

## ***Memory Allocation--***

### ***How Much RAM and How Much ROM?***

RamKeeper gives you the ability to have both a RAM Disk to quickly store and retrieve data, and a ROM Disk for more permanent storage. You'll need to decide how much of the total available memory you want to use as volatile RAM and how much as a non-volatile ROM Disk.

### **Why not use all available memory as a ROM Disk?**

Since the ROM Disk remains intact when you turn off your computer, it might seem logical to allocate all available memory as a ROM Disk. However, as mentioned earlier, many applications need RAM for desktop space, so you'll need to Leave some of the RAM available for use by the system.

### **Is a RAM Disk now obsolete?**

Almost but not quite. Because you can set the size of the RAM Disk to 512K and 800K, there are some cases in which a RAM Disk is very useful. Such a case is copying disks.

If you've ever tried to copy a 5.25 disk or a 3.5 disk to a RAM Disk file or a hard disk, you have probably gotten the message:

```
    "The two disks are different sizes, so
    the contents of "YOUR DISK" will be placed in a
    folder on "RAM#".
```

This creates a folder that you may or may not want but more importantly, it copies the files in segments instead of all at once.

Result: Slower copies.

Remedy: Create a 512K or 800K RAM Disk.

This allows you to copy from floppy disks to a RAM Disk much more quickly. To set up a 512K or an 800K RAM Disk, follow the instruction in your IIGS User's Guide.

### **RAM and the GS Control Panel**

You may notice that the actual size shown next to RAM Disk size in the Control Panel-RAM Disk menu is smaller than the Minimum RAM Disk Size. This is because RamKeeper overrides the GS Control Panel's RAM Disk allocation. For example, if you set your Minimum RAM Disk Size to 800K in the RAM Disk menu, but only leave 256K for use as a RAM Disk in the AE RamKeeper's - Initialize ROM Disk or change ROM Disk Size menus, the actual size of the RAM Disk will be 256K.

This causes no particular problems -- as mentioned earlier, you'll want to use most of your memory as ROM Disk space anyway -- we just wanted to point it out for those who might wonder.

# CHAPTER SEVEN

---

## **Æ** Cache

Those of you who want to know what the Cache™ is and does, read, “About the Cache™” at the end of this chapter. Those of you who want to install it right away, here's how...

### Requirements

To use the **Æ** Cache, you must have the following:

- ◇ A RamKeeper card with any compatible memory card attached.
- or
- ◇ A GS-RAM™ card installed in the IIGS's Memory Expansion Slot.
- ◇ An Apple 3.5 Drive.
- \* *Note:* The Cache supports only the Apple Disk 3.5™ Drives (platinum). It will not cache the Apple II Uni-Disk™ 3.5 drives (white) nor will it cache 5.25” drives or hard disks.

**Important:** You must set Slot 5 in the Control Panel menu to the Smart Port Setting.

- ◇ A COPY of the AW 2 Expander disk, version 2.5.3 or later.

### Installing the Cache

You may have noticed that there are two AECACHE files on the AW2 Expander disk. One is for use with ProDOS 8 only while the other is for use with both ProDOS 8 and 16. First, decide if you'll be using ProDOS 8 only or ProDOS 16 only or if you'll be switching between the two, then follow the appropriate directions below.

#### ProDOS 8 Only

If you plan to use only ProDOS 8:

- 1.) **Boot your COPY of the AW 2 Expander disk**



2.) Select  $\mathcal{A}$ E Cache from the AW2 Expander main menu or execute the file,  
AECACHE.SYSTEM.

While executing, the program will display the  $\mathcal{A}$ E startup screen accompanied by the message:

INSTALLING....

at the bottom of the screen.

If the  $\mathcal{A}$ E Cache program does not find a properly installed RamKeeper or GS-RAM card it will print the following message to the monitor:

REQUIRES GS-RAM  
OR RAMKEEPER W/ MEMORY CARD  
IN IIGS MEMORY EXPANSION SLOT

- \* *Important:* Switching from ProDOS 8 to ProDOS 16 with AECACHE.SYSTEM operating will cause unpredictable results. If you want to switch between operating systems, follow the directions for ProDOS 8 and ProDOS 16 following.

### ProDOS 16 and ProDOS 8 or ProDOS 16 Only

If you'll only be using ProDOS 16, or if you'll be switching between 16 and 8, use the IIGS Finder or System Utilities to copy the Aecache.Setup file (from the AW2 Expander disk) into the System. Setup folder located within the ProDOS 16 System folder on your boot disk(s) (see below).

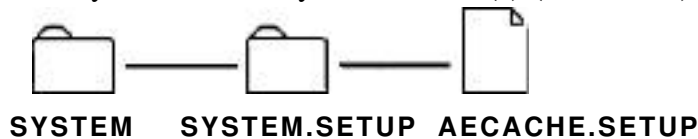

### Where the file goes

Booting these modified disks will load the AE Cache option into your Classic Desk Accessories menu.



- \* *Note:* You must cold boot into ProDOS 16 to enable the AECACHE.SETUP file to work under both systems. You can then switch between ProDOS 8 and ProDOS 16 without deinstalling or reinstalling the  $\mathcal{A}$ E Cache

If the  $\mathcal{A}$ E Cache program does not find a properly installed RamKeeper or GS-RAM card, the AE Cache option won't appear in the Desk Accessories menu.

## Setting the **AE Cache Size**

Once the **AE Cache** is installed, it will automatically increase your productivity. All you need to do is decide how large you want the **AE Cache** to be.

### 1.) **Access the IIGS Classic Desk Accessories Menu.**

(- then ). You should see a menu much like the one below. (Yours may be slightly different according to the Classic Desk Accessories you have loaded.) Notice the new option **AE Cache**.

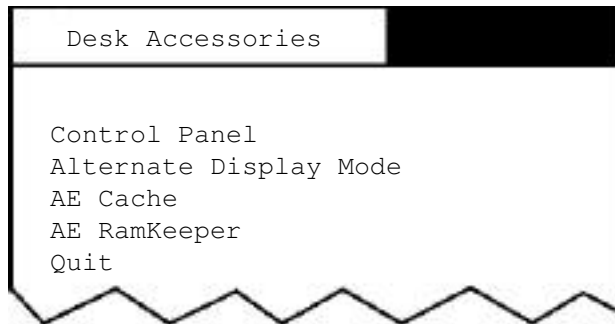

### **Classic Desk Accessories Menu**

- 2.) **Select the new option** using the arrow keys and return. You'll see the **RAM Cache** menu. (See illustration.)
- 3.) **Change the size of the RAM buffer** to the size you want by pressing the right and left arrow keys to increase and decrease. You don't have to power your computer down and back up to change the size of the cache. Simply select the size you want then press return. If you access the **AE Cache** option again, you will see that your new setting has taken affect.

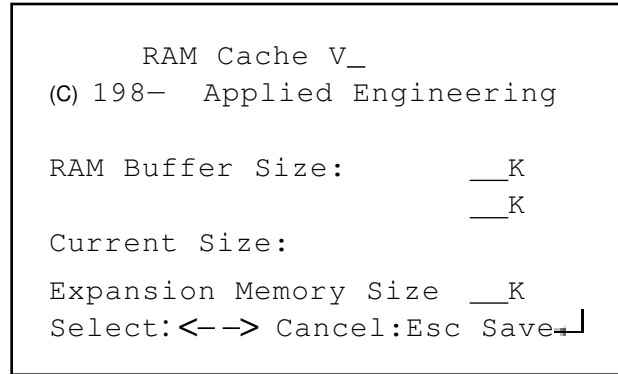

## RAM Cache Menu

- 4.) **Change the size of the RAM buffer** to the size you want. Press the right and left arrow keys to increase and decrease the RAM buffer size.

You don't have to power your computer down and back up to change the size of the cache like you do when you change the size of a regular RAM Disk. Simply select the size you want then press return. If you access the `AE CACHE` option again, you'll see that your new setting has taken effect.

## Setting the RAM Buffer Size

The `Expansion RAM Size:` heading displays the entire amount of memory on the memory expansion card. If another program or utility is using some of the extended memory, the RAM Buffer will not be able to use all of the memory indicated by the `Expansion RAM Size:`. But it can use the free memory available at that time for a RAM Buffer.



If you request more memory than is free at the time, the `Cache` will use as much free memory as is available. The `Cache` won't automatically fulfill your size request once the memory becomes free. If a program frees any memory, you can use that memory as a RAM Buffer by resetting the `RAM Buffer Size` in the `AE Cache` option in the Desk Accessories menu.

## Removing the **Cache**

To remove the **Cache** from the system:

### ProDOS 8

Cold boot your computer by doing either of the following:

- > Press and hold down the control and open-apple keys (-) while pressing and releasing the reset key.
- > Power down--turn off the computer, then power up--turn it back on.

After you cold boot, access the Desk Accessories menu and note that the `AE Cache` option is gone.

### ProDOS 16

Remove the `AECACHE .SETUP` file from the System. Setup file and reboot or cold boot from a boot disk that doesn't have the `AECACHE .SETUP` file installed.

## About the **Cache**

Part of the reason the **Cache** is so incredibly fast at retrieving information is that it allows ProDOS to read a whole track every time it accesses the disk drive instead of reading individual blocks. This method, called, track caching, makes even the initial read much faster--up to twice as fast as a system without a cache. All subsequent calls are sped up even more because the system does not have to access the disk drive every time you request information. In fact, subsequent accesses are often faster than accesses from a RAM Disk!

The **Cache** installs itself onto the Smart Port and will operate with ProDOS 8, ProDOS 16, Apple Pascal 1.3, and `AE's PC` program for CP/AM. It uses some of the expanded memory for itself plus the amount of memory you allocate to it.

When the cache program reads a track, it stores the entire track in the Track Buffer and stores the block(s) containing the requested information in another buffer, the Cache Buffer. You can set the Cache Buffer to the size you want, depending upon the memory size of your GS-RAM card and how much of that memory you have allotted for use as a RAM Disk.

When the Cache Buffer becomes full, it will make room for the most recently requested data by replacing the blocks that have been stored in the buffer the longest without being accessed. The Track Buffer is not variable; it is large enough to hold one track (6K) and cannot be changed.

When you call for information, the system first looks in the Cache Buffer. If the information is there, it reads it with speed comparable to (often even faster than) reads from RAM Disks and internal hard disks. If it doesn't find the information in the Cache Buffer, it checks the Track Buffer. This takes very little more time than reading from the Cache Buffer because the system is still not required to read the disk drive.

If the information is not in the Track Buffer, the system will then go back out to the disk drive, find the information and read the entire track to the Track Buffer. This new track replaces the track currently held in the Track Buffer.

While this method actually goes through more steps than a non-cached system to get information that is not stored in the buffer, the actual time it takes the system to check the Cache Buffer and Track Buffer is insignificant.

## **Copy Protected Programs**

Some copy protected programs have a disk accessing function of their own and cannot use the **Cache**. However, most programs will use the cache with no problem.

# CHAPTER EIGHT

## ***AW 2 Expander***

The AW 2 Expander is an accessory program designed to compliment Applied Engineering memory expansion products. It modifies the AppleWorks™ program to recognize and use the additional memory provided by these products.

The AW 2 Expander program will enhance AppleWorks USA version 2.0, German 1.4, and French 1.4.

### **Before You Even Think of Modifying AppleWorks...**

If you are familiar with AppleWorks, you'll probably be tempted to use the AW 2 Expander without reading these instructions. Resist the temptation. Or at least read the following.

- AW 2 Expander does not support AppleWorks versions 1.0 through 1.3.
- These instructions assume that you already know how to use AppleWorks. The AW 2 Expander program uses the same screen displays and keyboard input routines (user interface') as the AppleWorks program. If you need a quick review, read Throughout AppleWorks in your Using AppleWorks manual.
- There's an AppleWorks Word-Processor file on the AW 2 Expander disk entitled "**READ.ME.**" Please do so. This document contains information about any recent changes to the software or updates to the documentation.
- Apply the AW 2 Expander modifications only to unmodified BACKUP copies of your AppleWorks startup and program disks. Modifications required by other programs should be done after executing the AW 2 Expander enhancements.

## AppleWorks Modification Instructions

This is how to use the AW 2 Expander to modify the AppleWorks disks:

1. First, make copies of your original AppleWorks disks. Filer provided on the AW 2 Expander disk, or the copy program on your System Utilities disk should be used for this purpose.  
  
\* *Note:* You must give the same name to the front and back side of the AppleWorks copy disk.  
  
Instructions for copying with Filer are in the Appendix of this manual. Instruction for copying with the System Utilities are in the IIGS System Disk User's Guide.
2. Boot the AW 2 Expander disk in your startup drive.
3. Select option 1 - "Execute AppleWorks Enhancements."
4. The Applied Engineering AW 2 Expander copyright screen will then appear. After reading each of the screens, press the space bar to continue.
5. You'll now be prompted to remove the AW 2 Expander disk and insert a COPY of the AppleWorks STARTUP disk in drive one. Be sure the WRITE PROTECT tab has been removed from the disk. As prompted at the bottom of the display screen, press the space bar to continue or the escape key to go back to the main menu.

The AW2 Expander program expects to find the AppleWorks STARTUP file, "APLWORKS.SYSTEM," on the disk in drive one. If, at this point, the program displays the following message:

```
Cannot find correct file
Please enter the prefix of the AppleWorks program
?
```



enter the complete ProDOS prefix of the AppleWorks STARTUP disk. Be sure to include any (/) slashes for subdirectories.

An example ProDOS prefix of an AppleWorks subdirectory on a Apple 20 SCSI hard disk (with a volume directory name of /HARD) might be: /HARD/APPLEWORKS.

6. The program will then give you a list of the modifications that it will make to your AppleWorks disk(s) and ask you if you want to continue. If you want to go ahead and make these modifications to your AppleWorks disk(s), hit the “Y” key. If you don’t want to make these modifications, hit the “N” key to return to the main menu.
7. After the STARTUP disk has been successfully modified, you may be prompted to remove it from the disk drive and insert a COPY (write enabled) of the AppleWorks PROGRAM Disk. The volume directory name of this disk must be the same as the STARTUP disk. Press the space bar to continue.
8. When the modification to the AppleWorks PROGRAM Disk has been completed, the program will prompt for a key press to quit. Press the space bar and the modified AppleWorks can then be booted in the normal manner.

## Setting the AppleWorks Enhancement Options

Boot the AppleWorks startup disk just like you normally would. (Notice that the AppleWorks version number near the lower right corner of the startup screen now has an “A” tagged onto its end (Ex: 2.0A). If it doesn’t have an “A: appended to the version number, it hasn’t been modified correctly.

When the startup disk has finished loading, remove the startup disk and insert the program disk, but DO NOT press return. Press  instead. If you’re booting AppleWorks from a UniDisk 3.5 or a hard disk, press  when you are prompted with: “Press the Space Bar to continue.

- \* *Note:* It’s not necessary to access the Getting Started options menu each time you boot AppleWorks. The Getting Started menu is only used to set the enhanced AppleWorks options.



The current enhancement-options configuration will be read from the parameter file (SEG.PR) on the AppleWorks program disk and displayed in the Getting Started option menu. The configuration shown contains the default settings. These default settings remain in effect until you change them and save the new configuration back to the AppleWorks program disk.

File: None GETTING STARTED

---

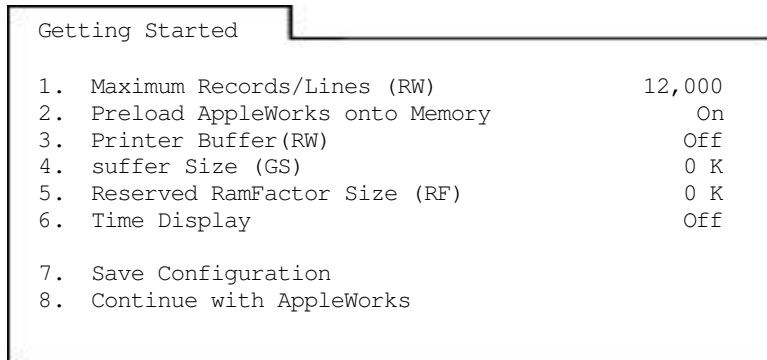



---

Type number, or use arrows, then press Return 1113K Avail.

## The Getting Started options menu

- \* *Note:* The options followed by (RW) are for RamWorks and Z-RAM products only. Those followed by (RF) apply only to the RamFactor. (GS) applies to the IIGS only.

Use the up and down arrow keys (   ) to highlight the option you want. Use  to select a highlighted option. For more information on the options, refer to the section entitled *About the New Features*. When you have made the desired changes, save the new configuration back to the AppleWorks program disk by selecting the menu option `Save Configuration`.

Choose the option, `Continue with AppleWorks`. If you didn't save your new configuration, the new one will be in effect only until you quit the AppleWorks program. The next time you boot AppleWorks, the previous (saved) configuration will be used.

## About the New Features

The following paragraphs describe the new features of the enhanced AppleWorks and the instructions for using them. Please read this section very thoroughly.

### More Word-Processor Lines and Database Records

With sufficient memory, the maximum number of Word Processor lines available with the unenhanced AppleWorks 2.0 is limited to 7,250; the maximum number of data base records is 6,350. The enhanced version expands the maximum number to just over 22,600 apiece.

The enhanced AppleWorks, when RamKeeper with a GS memory card is installed, automatically sets the number of lines and records to the maximum (22,600).

### Clipboard Expansion

The standard AppleWorks clipboard (2.0) is limited to only 255 lines of information. The enhanced AppleWorks clipboard expansion increases the clipboard size for the Word Processor and Database functions to 2,042 lines. Only clipboard activities within and originating from the Spreadsheet function remain limited to 250 lines.

### Printer Buffer Option

The Apple IIGS has a built-in print buffer which can be activated from the Apple IIGS Control-Panel menu. You may select the "On" setting from the `Printer Buffer` option but the buffer will be functional only if you have selected it from the Control Panel option. If you'd like to know more about the internal printer buffer, please refer to your Apple IIGS Owner's Guide.

### Buffer Size Option

The `Buffer-size` option of the `Getting Started` options menu affects the size of only the Apple IIGS' internal printer buffer.

- \* **Important:** If any amount of memory is allocated to the `Buffer size` option, the printer buffer setting is shown to be "On." However, it will not actually be on if not selected from the `Control Panel` menu.

The `Buffer-Size` option of the enhanced AppleWorks `Getting Started` menu lets you allocate the amount of Apple IIGS memory space (up to 64K) to be used for the print buffer. With the Apple IIGS print buffer ON and the `Getting Started Buffer Size` option set to OK, the actual buffer size will be determined by the amount of memory (2K or less) that the Apple IIGS memory manager can allocate.

### **Time Display/Database Time-Stamp Option**

This option will read the output of the Apple IIGS internal clock and replace the "Open-Apple-? for Help" message in the bottom line of the AppleWorks screen with a current date and time display. This option also allows the AppleWorks user to enter the current date or time into a database category by typing the @ character as the only entry in that category. The category name must contain either the word DATE or the word TIME but should not contain both. For example, you should not use this feature in a category named, "Date and Time."

- \* *Note:* To use the internal clock of the Apple IIGS, the enhanced AppleWorks must be run under ProDOS 8 or 16, not ProDOS 1.1.1. (See your Apple dealer for ProDOS upgrades.)

The `Getting Started` options menu allows 12 hour or 24 hour time and date display. How the date is displayed on the screen is affected by the time display option selected.

The 12-hour (USA format) option displays the date as Month/Day/Year.

The 24-hour (French, German, and military format) option displays the date as Day/Month/Year.

## Multiple-Disk Save

Data storage problems arise when the size of a file on the Desktop exceeds the amount of storage space on the data disk. A standard floppy disk can store only 135K of AppleWorks data. Using the modified AppleWorks, Desktop files larger than the available disk space will be segmented, or “split” and saved in sections to two or more disks. The following paragraphs explain how to use this feature to save and load segmented Desktop files.

This seems to be a good time to remind you of Murphy’s

Law:

Whatever can go wrong will go wrong.

Back up your Desktop files! A power failure will wipe out anything currently on the Desktop! It’s always a good idea to have backup copies of your working data disks, especially if you have large amounts of data stored on them.

## Saving Multiple Files to Disk

When saving a Desktop file which is larger than the data disk space available, the enhanced AppleWorks will prompt the user with the following message:

```
Segmented Desktop File...
Please insert NEXT disk with SAME
VOLUME NAME
```

\* *Note:* If a previous version of the file already exists on the disk, AppleWorks will first ask you if you wish to delete the old file.

Remove the data disk from the current disk drive and replace it with the next data disk. All segments of a given segmented Desktop file **MUST** be saved on data disks having the same volume (disk) name as the primary (first) data disk. On subsequent data disks, each appended file segment (sequential) will be automatically deleted before saving a new segment.

If you discover that you don’t have enough formatted blank disks with the same volume name, don’t panic! Press *esc* then space to continue. Just use the AppleWorks Disk Formatter utility under the “Other Activities” menu before you begin to save your file.

## **Adding Multiple Disk Files to the Desktop**

When adding multiple-disk or segmented files to the Desktop, the file **MUST** be loaded from the data disks in the same sequence as it was saved. AppleWorks will prompt the user to insert the **NEXT** data disk(s) until the file is completely loaded.

If you list the files on disks that contain segmented files you'll notice that the first segment has the filename that you gave it. The next segment (on the **NEXT** disk) will have a ".2" appended to the end of your filename. The next disk in the sequence will have a ".3" appended to the filename and so on. In this way, AppleWorks helps the user keep track of the segmented Desktop file sequence. You'll probably want to label your data disks in such a way that you too can keep track of the proper sequence. You may segment up to 9 disks (".9") in this manner.

## **Print-File Cache**

One small file (SEG.PR) on the AppleWorks program disk contains special configuration information about such things as your printer information, standard location of your data disk, and enhancement options. The unmodified version of AppleWorks leaves this information on the program disk and is not preloaded along with the program overlays.

When AppleWorks needs information from this file it prompts you to reinsert the AppleWorks program disk. The enhanced version of AppleWorks loads this file into memory at startup and eliminates the need for the program disk (until overlays are bumped from memory). Only when you change the contents of this file does the enhanced AppleWorks prompt you to insert the program disk.

# **APPENDIX A**

## ***Trouble Shooting***

This section includes a few methods of working around problems that you may encounter.

### **Cards are not retaining stored files**

- ◇ Open the computer and see if both LED lights are on.
  - If the LED closest to the back edge of the card is not on, check the transformer wall connection as well as the card connection. Are both plugged in?
  - If the other LED is off, make sure that the wires are connected to both terminals of the battery, positive to positive, negative to negative. Make sure that the two-pin female connector is attached correctly--wires feeding toward the bottom of the card.
- ◇ Test cards individually using the testing methods provided with each card.
- ◇ Verify that any RAM chips added to the memory cards meet manufacturers specifications.

### **Battery not holding charge**

- ◇ Make sure your wall transformer is not plugged into a switch controlled socket or a dimmer switch. If it is, any time you turn off the switch (or turn down the dimmer) the RamKeeper is getting its power from the battery.
- ◇ Using a transformer other than the one supplied with the RamKeeper may cause your card not to work properly or your battery not to recharge as it should.

### **In an area that has a lot of power outages**

- ◇ You may need additional battery backup time. You can increase the battery backup time of your Gel/Cell by linking several Gel/Cell batteries together. You can purchase additional Gel/Cell batteries from Applied Engineering Sales.

- ◇ Power outages are typically accompanied by transient surges of power. If you have not already, consider adding a line filter/surge protector to protect your computer, RamKeeper and the battery. Surge protectors are available at most computer stores and Radio Shack®.

### **AE RamKeeper doesn't appear in Desk Accessories**

- ◇ You need to copy the file `AERAMKEEPER` from the ROM Disk to the `DESK.ACCS` folder in your boot disks System folder. (See *Loading the Firmware* in Chapter Two.)

### **Can't boot from floppy drive**

- ◇ `Slot 5` must be set to `Smart Port` and `Startup Slot` should be set to `Scan` in the IIGS Control Panel.

### **“Invalid RK Configuration” Message**

- ◇ you get this message when you try to boot, it is because the card on back of the RamKeeper in a two card arrangement is not configured with a multiple of 512K. The back card must have 512K, 1 Meg, 1.5 Meg, 2 Meg, 3 Meg, etc; 256K and 768K on the back card will not work.

### **Can't change ROM Disk size to more than 2,048K**

- ◇ You have reached a ProDOS block boundary. You'll need to reinitialize the ROM Disk for a new setting of more than 2,048. (See *More than 2 Meg* in Chapter Two.)

### **“Unable to Load ProDOS” Message**

- ◇ If you're trying to boot from ROM, the system folders must be on the main level (the root directory) of the ROM disk. If you dragged the icon of the System disk to the AEROM disk (using the Finder), all the boot files will be in a folder of their own on AEROM. You'll need to open this folder, use the `Select All` option, and drag the folder's contents to AEROM. You can throw away the now-empty folder.

# **APPENDIX B**

## ***A Brief ProDOS Tutorial***

This is a brief explanation of the Professional Disk Operating System, ProDOS for those who are completely new to it. All of this information and more is included in your Apple Owner's Guide but we have provided it here for your convenience.

### **Operating System**

ProDOS is one of several operating systems for the Apple. Others include DOS 3.3 and Pascal. Operating systems, as defined in the Apple Owner's Guides, are programs that control how information is loaded into memory, how the computer handles the information, how the information is stored on a disk and how the computer communicates with the printer and other peripherals.

### **Naming Volumes**

ProDOS must have a way to locate which disk (often called "volume") you want to access. Instead of typing in the location of the disk as in DOS 3.3 (ex: S6,D1), you simply type in the name of the disk (the volume name). Some rules for volume names are:

- 1) Name can include letters, numbers or periods but not spaces
- 2) Name must begin with a letter
- 3) Name can be up to 15 characters long

These rules also hold true for subdirectory names.

### **Root Directory and Subdirectory**

The main directory of the volume is called the root directory. The root directory uses the same name as your disk. Sub-directories are ProDOS' way of organizing information on a disk.

Think of the root directory as a file drawer and the subdirectories as folders within the drawer. You can:

- 1) put files directly into the root directory like putting documents straight into the file drawer



- 2) put files within subdirectories like putting documents in folders
- 3) put subdirectories within subdirectories like putting folders within folders.

## Pathname

The name of the directory combined with the names of one or more subdirectories is called a pathname. Volume names and subdirectory names are preceded by a slash, “/”. (Note that some applications add the slash for you.) For example, you could have a volume named /MY.DISK and have a file, called /MY.FILE on the root directory of that disk. To access that file, you would use the pathname /MY.DISK/MY.FILE. You could also have a file, /JUL.AUG in a subdirectory (folder) called, /PHONE on a disk called /BILLS. To access that file, you would use the pathname, /BILLS/PHONE/JUL.DEC. Refer to the diagram below.

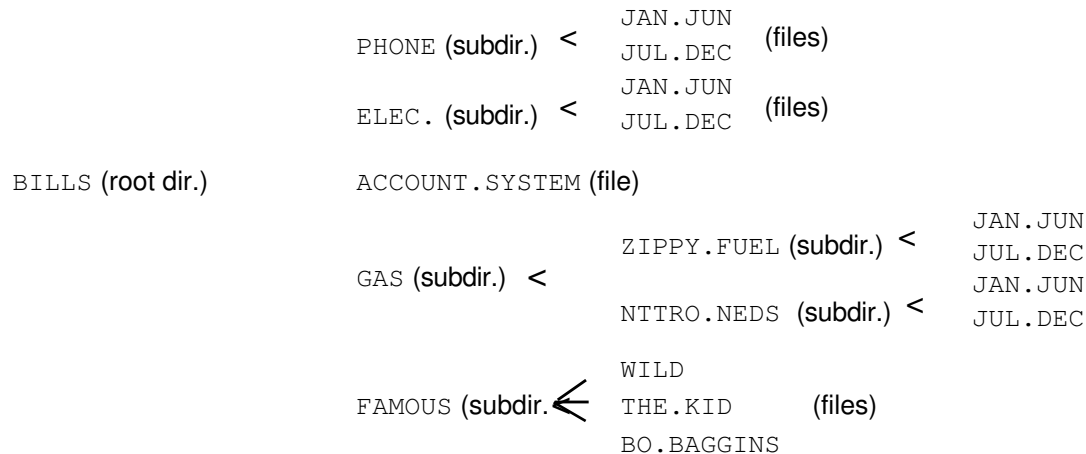

## ProDOS Directory Structure

Now when an application asks you for the pathname of a file, you'll have a basic understanding of what it expects.

### System Files

A system file is a ProDOS file that starts an application. Typically, these files have the suffix, .SYSTEM (e.g. /APLWORKS .SYSTEM, /ACCOUNT .SYSTEM [see above], etc.). When you boot ProDOS, it runs the first system file listed in its directory. So, if BASIC.SYSTEM is the first system file on your ProDOS boot disk, ProDOS will boot then put you in BASIC.

## **Additional Resources**

The following books are available through most Apple dealers:

**Apple II Owner's Manual** (Apple Computer, Inc.)

Supplied with your Apple Computer. Take the time to read it.

**Basic Programming with ProDOS** (Addison-Wesley Publishing) Gives a detailed explanation of how to use ProDOS from AppleSoft Basic.

**Beneath Apple ProDOS** (Quality Software) Provides information about ProDOS for both the novice Apple user and the advanced programmer.

**ProDOS Inside and Out** (TAB Books) Vary good book for both the beginning and advanced BASIC Programmer.

**ProDOS Users Manual** (Apple Computer, Inc.)

Provides an overview of ProDOS and explains how to use the ProDOS User's Disk.

## APPENDIX C

### ***Copying Disks with Filer***

We have included Filer, a utility program, on the AW 2 Expander disk to enable you to make backup copies of your disks that are not copy protected. The instruction below tell you how to use Filer to copy from disk to disk. See Chapter 2 for instructions on using Filer to copy AppleWorks to your RamFactor.

1. Load Filer.
2. Select "Volume Commands" (v)
3. Select "Copy a Volume" (C). The settings default to a two drive set up with your master in Slot 6 Drive 1 and your copy disk in Slot 6, Drive 1. Adjust to your set up. (If you only have one drive you can copy from S6, D1 to S6, D1.)
4. Press return to accept the default settings or enter your own.
5. Insert the master disk in your drive that you have set the program to copy from. Insert a blank disk (it does not need to be formatted) in the drive you have set the program to copy to. The blank disk must have the write protect tabs removed.
6. Press the Return key.
7. Name your volume. It will default to the name of the master disk (ex: When copying AppleWorks, the volume name will default to "/APPLEWORKS". Hit return or give it a different name. (You must give the front and back side of AppleWorks the same name.)
8. When you press return, the copy program will begin formatting the copy disk. Then the words "READING" and "WRITING" will flash on and off the screen to entertain you while you wait.
9. When the program is finished copying, it sends the message, "COPY COMPLETE" to the screen.
10. Remove both disks. Put your master disk in a safe place and label your copy disk. You will make your modifications to the copy disk.

For additional help with the Filer program, contact your Apple dealer.

# APPENDIX D

## ***Bird's Better 'Bye'***

Several of the Applied Engineering distribution disks contain a modified version of ProDOS 8. It incorporates a program selector, Bird's Better 'Bye' (created by Alan Bird), that lets you exit one system file and easily run another system file (e.g. APLWORKS.SYSTEM, BASIC.SYSTEM, FILER) from a menu.

To use this 'BYE' command, boot your copy of the Æ disk or copy the 'PRODOS' file from the Æ disk to your boot disks. Then, anytime you quit a system program (such as AppleWorks), a menu of all the executable System files on that disk will be displayed on the screen. This menu can also be called from the Applesoft BASIC prompt by entering the 'BYE' command.

```
ESC: CHANGE VOLUME
RETURN: SELECT FILE

/AW2.EXP
  PRODOS
  AE.AW.SYSTEM
  FILER
  GSTEST.SYSTEM
  RWTEST.SYSTEM
  RFTEST.SYSTEM
  AECACHE.SYSTEM
```

### **Sample screen display**

The sample screen above shows the AW 2 Expander disk on-line and lists its executable System files.

Use the up and down arrow keys to highlight the selection you want to run. The ESC key will change the volume (disk) selection to the next on-line volume. The Return key selects the currently highlighted file or subdirectory name.

Subdirectory names on the disk will be indicated by a '/' as the first character of the file name.

# APPENDIX E

## *Getting Help*

If you have a technical question relating to your RamKeeper card that is not covered in the manual, please contact the dealer from whom you purchased the card. If you are experiencing difficulties with one particular program, contact the programs author or publisher.

In the event that the dealer or the publisher's support personnel cannot answer your question, call Applied Engineering Technical Support. The support representatives are experienced in the applications and uses of Applied Engineering products, but in order to provide a quick and effective answer to your question, they will need to know as much as possible about the hardware and software specifically related to your question. Please provide the technical support representative with the following information:

- ◇ The Applied Engineering product related to your question and its revision number.
- ◇ The original and current memory configuration of the card (if applicable).
- ◇ The model and revision of your computer.
- ◇ What peripherals are being used and what cards are in each slot.
- ◇ The name, version, and revision level of the software that you are experiencing problems with.
- ◇ The results of any test programs, diagnostics, or troubleshooting done by you, your dealer or your software publisher's support department.

Applied Engineering  
Technical Support  
(214) 241-6069

9 AM to 12:30 PM & 1:35 PM to 5 PM(CST)

Monday Through Friday

(Please call only the number above for technical support.  
Our sales office cannot transfer calls to the support lines.)

## Returning a Product

### Include

If your product needs to be returned, the technical support representative will give you a Return Material Authorization (RMA) number.

- ◇ Record the RMA number for your own records.
- ◇ Write the RMA number on the outside of the package you send to us.
- ◇ Write the RMA number at the top of the return form included with your product package.

Fill out the Return Form on back of the yellow sheet marked, "Attention! A correctly completed form will greatly reduce the time it takes to process and return your product.

Attach a copy of your original invoice to the return form.

- \* **Warning:** If you don't include an invoice products will be treated as out of warranty products and will be returned to you C.O.D. for the amount of the service charge.

A completed form should look something like the one below.

**Invoice**

If you should ever have to return your PC product for repair, please complete this form and attach a copy of your original invoice.

RMA Number: 9009055151

Computer:	Package:	Serial #:	1) Driver Driver
<input type="checkbox"/> PC	<input checked="" type="checkbox"/> Monitor	<u>ASUS/PC/101</u>	2) Driver CD-ROM
<input type="checkbox"/> Laptop	<input checked="" type="checkbox"/> Printer	<u>ASUS/PC/101</u>	3) Driver CD-ROM
<input type="checkbox"/> PDA	<input type="checkbox"/> Modem	<u>ASUS/PC/101</u>	4) Driver CD-ROM
<input type="checkbox"/> PDA	<input type="checkbox"/> Other (List):	<u>ASUS/PC/101</u>	5) Driver CD-ROM
<input type="checkbox"/> PDA			6) Driver CD-ROM
<input type="checkbox"/> PDA			7) Driver CD-ROM
<input type="checkbox"/> PDA			8) Driver CD-ROM
<input type="checkbox"/> PDA			9) Driver CD-ROM
<input type="checkbox"/> PDA			10) Driver CD-ROM

Set 1 (1) Part: \_\_\_\_\_ Set 5 \_\_\_\_\_

Set 2 \_\_\_\_\_ Set 6 \_\_\_\_\_

Set 3 \_\_\_\_\_ Set 7 \_\_\_\_\_

Set 4 \_\_\_\_\_ Set 8 \_\_\_\_\_

**Description of Software:** ASUS/PC/101

I've been using "Smart Scan" with "Real Life" since I first got it even though I've used it more than once. My neighbors have begun to complain about the noise. The noise is also killing my flora.

Description of Software: ASUS/PC/101

I've been using "Smart Scan" with "Real Life" since I first got it even though I've used it more than once. My neighbors have begun to complain about the noise. The noise is also killing my flora.

**Steps to Diagnose Problem:** Turn on computer and monitor, wait until red light on disk drive comes on, take round dial out of plastic cover and insert into the drive. That's all I do. Then the smoke starts pouring out. It keeps with both scan and application.

## When You Ship

If you don't have the original packing material, wrap the board in anti-static material (preferably the anti-static bag in which the card was originally shipped, however, aluminum foil will work fine). Pack it in a sturdy box cushioned with wadded papers (i.e. used computer paper or newspaper).

- \* **Warning:** If your product is damaged due to inadequate packing, your warranty will be void.

Include the return form and invoice.

Send the package, shipping prepaid, to:

**RMA# \_ \_ ? \_ \_**  
**Applied Engineering**  
**Technical Support**  
**3210 Belt Line Road, Suite 154**  
**Dallas TX 75234**

You should insure your package. Æ will not assume any responsibility for inadequate packing or loss or damage during shipping.

## When We Receive

Our service department will use your completed form in an attempt to duplicate the problem.

If it is determined that your product is defective due to a manufacturing defect, your card will be repaired or replaced at Æ's option.

Any misuse, abuse, or non-Æ authorized alteration, modification and/or repair to the Applied Engineering product will void the warranty. This warranty will also be void if you use the Æ product for any purpose other than its intended use.

Your product will be fully tested before it is shipped back to you, transportation prepaid, via UPS regular delivery.

Once your product is received by Technical Support, it will be processed and delivered to our shipping department within 7 to 10 working days.